

# SKEMA

## INDOOR YLES

PAVIMENTI IN LEGNO WOOD FLOORING



## SKEMA

Superfici da vivere, dal 1992  
Living surfaces, since 1992

## PAVIMENTI IN LEGNO WOOD FLOORING

Ricerca estetica e valorizzazione della materia prima: i pavimenti in legno celebrano la tradizione e l'artigianalità e rispettano l'ambiente, come dimostrano le certificazioni d'origine. Alle collezioni in puro legno si affiancano quelle in legno potenziato nella resistenza, che utilizzano meno materia prima, e sono quindi ancora più sostenibili.

Aesthetic research and enhancement of the raw material: wood flooring celebrates tradition and craftsmanship and respects the environment, as proven by the certificates of origin. The pure wood collections are complemented by those in engineered wood, which use less raw material and are therefore even more sustainable.



**“Il legno, con matericità e forza espressiva, diventa diretto collegamento tra architettura e natura.”**

“Wood, with its materiality and expressive power, becomes a direct link between architecture and nature.”

# Yles

Hexagon, Kytos, Over and Tarsia design by Franco Driusso

**La creatività ridisegna le forme,  
la tradizione si trasforma  
in innovazione.**

Creativity reshapes forms,  
tradition transforms into  
innovation.

**Yles è il pavimento a moduli geometrici che reinterpreta in chiave contemporanea il tradizionale parquet, coniugando design e artigianalità. Linee e forme scandiscono superfici orizzontali e verticali, offrendo nuove prospettive per pavimenti e rivestimenti di parete. Le lavorazioni artigianali, come le spazzolature e gli effetti trama, esaltano la matericità del legno, restituendo un carattere autentico e raffinato.**

**I suoi punti di forza sono la grande varietà compositiva, resa possibile da nove formati e da elementi dalle forme differenti, la disponibilità di numerose collezioni e l'uso di legno tracciato e certificato, che conferma la qualità e l'origine Made in Italy del prodotto.**

**Yles rappresenta una vera rinascita del parquet: un pavimento che torna alle sue origini più nobili, riaffermando il legno come materia organica principe e offrendo all'interior designer infinite possibilità di progettazione.**

Yles is the modular geometric flooring that reinterprets traditional parquet in a contemporary key, combining design and craftsmanship. Lines and shapes define both horizontal and vertical surfaces, offering new perspectives for floors and wall coverings. Handcrafted processes, such as brushing and textured effects, enhance the material essence of wood, giving it an authentic and refined character.

Its strengths lie in the wide compositional variety—made possible by nine formats and elements of different shapes—the availability of numerous collections, and the use of traced and certified wood, which confirms the quality and Made in Italy origin of the product. Yles represents a true renaissance of parquet: a wooden floor that returns to its most noble origins, reaffirming wood as the prime organic material and offering interior designers endless design possibilities.



## Product

Yles - Folia, Natural

**NEUTRA**

AB

Kytos 570

Kytos 380

Kytos 190

Stylo

Folia

Hexagon

Kross

Tarsia

Tabula

Over

**NATURAL**

AB

Kytos 570

Kytos 380

Kytos 190

Stylo

Folia

Hexagon

Kross

Tarsia

Tabula

Over

**NUX**  
ABC

Kytos 570  
Kytos 380  
Kytos 190  
Stylo  
Folia  
Hexagon  
Kross  
Tarsia  
Tabula  
Over

**FERRUM**  
AB

Kytos 570  
Kytos 380  
Kytos 190  
Stylo  
Folia  
Hexagon  
Kross  
Tarsia  
Tabula  
Over

## HARENA

AB

Kytos 570

Kytos 380

Kytos 190

Stylo

Folia

Hexagon

Kross

Tarsia

Tabula

Over

## CARBO

AB

Kytos 570

Kytos 380

Kytos 190

Stylo

Folia

Hexagon

Kross

Tarsia

Tabula

Over



**Dati tecnici**  
Technical data

**Product**  
Yles - Folia, Polvere  
Yles - Tabula, Polvere

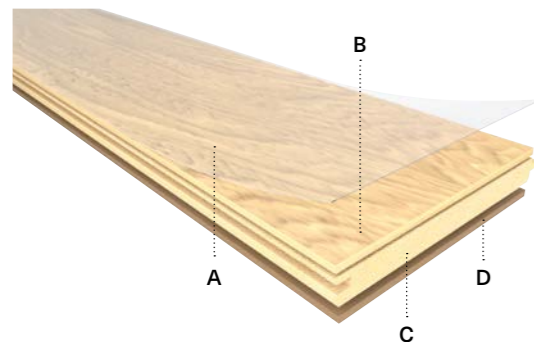

Yes

- A. Finitura Olio**  
Oil finish
- B. Legno rovere europeo o noce europeo 4 mm**  
European oak or european walnut wood 4 mm
- C. Listellare di abete 9 mm**  
Fir blockboard 9 mm
- D. Bilanciante in compensato di abete o derullato di pioppo 2 mm**  
Balancing layer in fir plywood or poplar veneer 2 mm

FORMATI/ FORMATS

<p><b>Yes - Kytos 570</b> 570x570x15/16 mm</p>	<p><b>Yes - Kytos 380</b> 855x380x15/16 mm</p>
<p><b>Yes - Kytos 190</b> 1710x190x15/16 mm</p>	
<p><b>Yes - Stylo</b> 1080x90x15/16 mm 1800x90x15/16 mm</p>	
<p><b>Yes - Folia</b> 537x190x15/16 mm</p>	<p><b>Yes - Hexagon</b> 329x190x15/16 mm</p>
<p><b>Yes - Kross</b> 450x90x15/16 mm 540x90x15/16 mm</p>	<p><b>Yes - Tarsia</b> 439x190x15/16 mm</p>
<p><b>Yes - Over</b> 540x90x15/16 mm</p>	
<p><b>Yes - Tabula</b> 1600&gt;2400x190x15/16 mm</p>	

CARATTERISTICHE TECNICHE/ TECHNICAL FEATURES

<b>Incastro</b> Joint		<b>M+F/ F+F</b>
<b>Bisello</b> Bevel		<b>4V</b>
<b>Reazione al fuoco*</b> Fire reaction*		<b>Dfl-s1</b>
<b>Posa incollata in aderenza totale</b> Fully bonded installation	✓	

\* Classificazione valida con l'utilizzo dei sottopavimenti e/o modalità indicate da Skema S.p.A. (per dettagli vedi scheda tecnica del prodotto e/o istruzioni per l'installazione).  
\* Classification valid with the use of underlayer and/or modality specified by Skema S.p.A. (please see product technical data sheet and/or installation instructions for details).

**Elementi con incastro femmina su tutti i lati e listello maschio.**  
Elements with female joints on all sides and male strips.

**Molteplici possibilità di posa.**  
Multiple installation options.

ESEMPI DI POSA/ PATTERNS EXAMPLES

<p><b>Kytos 380</b> 855x380x15/16 mm</p>	<p><b>Kytos 570</b> 570x570x15/16 mm</p>	<p><b>Kytos 190</b> 1710x190x15/16 mm</p>
<p><b>Kross</b> 450/540x90x15/16 mm</p>	<p><b>Stylo</b> 1080/1800x90x15/16 mm</p>	<p><b>Over</b> 540x90x15/16 mm</p>
<p><b>Tarsia</b> 439/190x15/16 mm</p>	<p><b>Hexagon</b> 329x190x15/16 mm</p>	<p><b>Folia</b> 537x190x15/16 mm</p>

**PROGRAMMA LIVE**  
LIVE PROGRAM

# Pavimenti in legno personalizzati

## Customized wood flooring

Il programma Live nasce per offrire la massima personalizzazione nella scelta di lavorazioni, finiture e colori, ampliando le possibilità dei pavimenti in legno Made in Italy. Le soluzioni disponibili includono doghe e spine (italiana e francese) con struttura a 2 o 3 strati, in diverse larghezze e lunghezze, in base alle disponibilità di magazzino.

I nostri team Customer Care e Project Management sono a disposizione per supportare richieste specifiche e fornire campionature per l'approvazione della produzione.

The Live program was created to offer maximum customization in the selection of processes, finishes, and colours, expanding the creative possibilities of Made in Italy wood flooring. Available options include planks and herringbone or chevron patterns with 2- or 3-layer construction, offered in various widths and lengths according to stock availability. Our Customer Care and Project Management teams are available to assist with specific requests and provide samples for production approval.

## Step 1: Lavorazioni

### Step 1: Processing

#### SPAZZOLATO BRUSHING



Lavorazione artigianale che conferisce alla tavola un gradevole aspetto segnato dal tempo.

Handcrafted process that gives the planks a pleasantly time-worn look.

#### PIALLATO HAND-SCRAPING



Lavorazione artigianale rigorosamente fatta a mano doga per dogha; la tavola viene "scolpita" anche contro vena per far risaltare maggiormente le caratteristiche del legno.

Each plank is meticulously handcrafted and even worked against the grain to highlight the natural character of the wood.

#### TAGLIO SEGA SAWING



Lavorazione artigianale che produce dei tagli trasversali importanti sulla tavola, rendendola "vissuta".

Handcrafted process that creates deep transverse cuts on the planks, giving them a beautifully weathered look.

#### TRAME TEXTURING



Lavorazione effetto trame, che riproduce una seghetatura dolce e non invasiva, simile alla texture del tessuto in garza.

A handcrafted finish with delicate saw marks that create a subtle texture, reminiscent of gauze fabric.

## Step 2: Trattamenti

### Step 2: Treatments

#### OSSIDATO OXIDATED



Tecnica naturale che avviene per reazione della materia eseguita in autoclave o per impregnazione e che dona un effetto invecchiato al legno.

A natural process that takes place through the material's own reaction, carried out in an autoclave or by impregnation, giving the wood an aged appearance.

#### OLIATO OILED



Finitura che prevede l'applicazione di olii naturali sulla superficie del legno, si distingue per la naturalezza del colore che il parquet assume mettendo in risalto venature e tonalità del legno.

A finish obtained by applying natural oils to the wood surface, enhancing its grain and tones while preserving the wood's natural colour.

#### VERNICIATO VARNISHING



Finitura eseguita applicando un film superficiale di vernice che protegge il legno dalle sollecitazioni meccaniche e chimiche, rendendolo più resistente e più facile da pulire.

A finish created by applying a surface layer of varnish that protects the wood from mechanical and chemical stress, making it more durable and easier to clean.

**ACCESSORI**  
ACCESSORIES

# Sottopavimenti Underlayers

## SUPERIOR RBR



Alte performance; densità media 800 kg/m<sup>3</sup>; soddisfa lo standard EPLF; ottima resistenza meccanica CS a protezione dell'incastro; alta performance acustica IS per riduzione riverbero in stanza RWS; bassa resistenza termica TR, consigliato per posa su massetti radianti; barriera vapore integrata (PET/Alu); bassissima emissione VOC; posa lato PET/Alluminio verso l'alto.  
High performance; average density 800 kg/m<sup>3</sup>; fulfils EPLF standards; excellent mechanical resistance CS to protect the joint; high acoustic performance IS for room reverberation reduction RWS; low thermal resistance TR, recommended for laying on radiant screeds; integrated vapour barrier (PET/Alu); very low VOC emission; PET/Alu side up laying.

**Dimensioni**  
Size

**Rotolo/ Roll 8x1 m**  
Sp. 2 mm | D 800 kg/mc

## DB



Costituito da schiuma poliolefinica a celle chiuse estrusa in modalità controllata; densità media 80kg/m<sup>3</sup>; soddisfa standard EPLF; resistenza meccanica CS; isolamento al rumore da calpestio IS; barriera vapore SD (PET) che evita diffusione di umidità di risalita, integrata con cimosa laterale dotata di nastro adesivo applicato per congiunzione materassini; senza CFC e HCFC, plastificanti e metalli pesanti; posa con lato nero con barriera vapore verso l'alto.  
Consisting of closed-cell polyolefin foam extruded in a controlled mode; average density 80 kg/m<sup>3</sup>; fulfils EPLF standard; mechanical resistance CS; impact sound insulation IS; vapour barrier SD (PET) preventing diffusion of moisture, integrated with side selvage with adhesive tape applied for mattress connection; free of CFCs and HCFCs, plasticisers and heavy metals; laid with black side with vapour barrier facing upwards.

**Dimensioni**  
Size

**Rotolo/ Roll 25x1 m**  
Sp. 2 mm | D 80 kg/mc

## ST



Costituito da schiuma poliolefinica a celle chiuse estrusa in modalità controllata; densità media 20kg/m<sup>3</sup>; soddisfa standard EPLF; resistenza meccanica CS; isolamento al rumore da calpestio IS; barriera vapore SD (PET/Alluminio) integrata che evita diffusione di umidità di risalita; senza CFC e HCFC, plastificanti e metalli pesanti; posare con lato metallizzato verso l'alto.  
Consisting of closed-cell polyolefin foam extruded in a controlled manner; average density 20 kg/m<sup>3</sup>; meets EPLF standard; mechanical resistance CS; impact sound insulation IS; integrated SD vapour barrier (PET/Aluminium) that prevents the diffusion of rising damp; free of CFCs and HCFCs, plasticisers and heavy metals; lay with metallised side up.

**Dimensioni**  
Size

**Rotolo/ Roll 25x1 m**  
Sp. 2 mm | D 20 kg/mc

**Rotolo/ Roll 150x1 m**  
Sp. 2 mm | D 20 kg/mc

# Battiscopa Skirting boards

## STAR



Battiscopa in HDF con proporzioni standard.  
HDF skirting board with standard proportions.

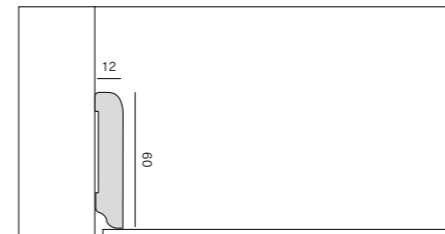

## TIME



Battiscopa in HDF.  
Skirting board made of HDF.

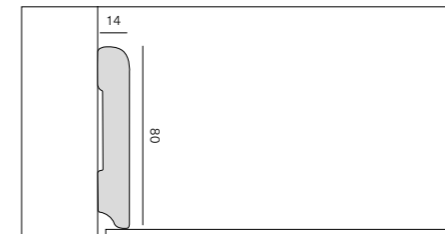

## LOOK



Battiscopa in HDF con finitura poro.  
Skirting board made of HDF with a pore finish.

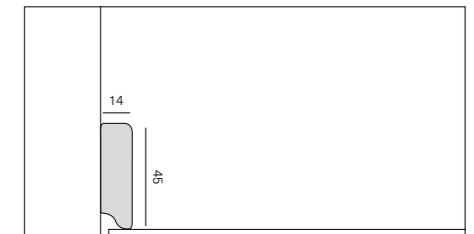

## ABACO / RECAP

	STAR	TIME	LOOK
<b>Abbinati</b> Matching	Facile+	Prestige L Prestige Gold	Prestige L Prestige Gold Vision Technic
<b>Abbinabili</b> Combined	Syncro Parquet	Lumbertech	-
<b>Tinta unita</b> Solid colors	○ Bianco opaco/ Matt white	○ Bianco lucido/ Glossy white ○ Bianco opaco/ Matt white ○ Grigio chiaro/ Light grey ● Grigio medio/ Medium grey ● Grigio scuro/ Dark grey ● Nero opaco/ Matt black ● Carbonio/ Carbon ○ Beige ○ Avorio/ Ivory ● Metallo bronzo/ Bronze metal	● Alluminio/ Aluminum ○ Bianco lucido/ Glossy white ○ Bianco opaco/ Matt white ○ Grigio chiaro/ Light grey ● Grigio medio/ Medium grey ● Grigio scuro/ Dark grey ● Nero opaco/ Matt black ● Carbonio/ Carbon ○ Beige ○ Avorio/ Ivory ● Metallo bronzo/ Bronze metal
<b>Dimensioni</b> Size	h 60-2400x12 mm	h 80-2400x14 mm	h 45-2400x14 mm h 45-2200x14 mm

**DROP**

**PVC ESPANSO**

**F**

**W45**

**W75**

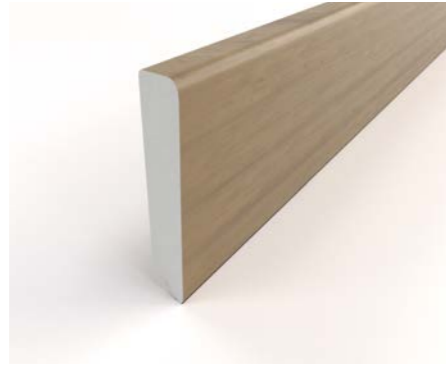
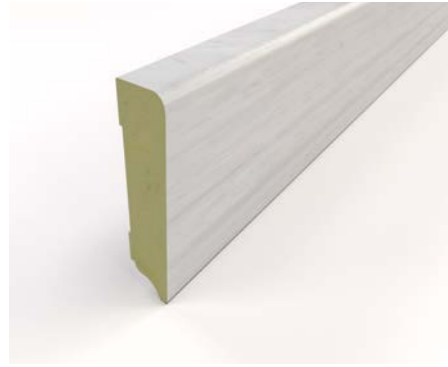

**Battiscopa in HDF a bassa assorbenza con finiture poro. Con densità di 700 kg/m<sup>3</sup> offre alta resistenza all'umidità.**  
HDF skirting board with low absorbency and a sealed finish. Its 700 kg/m<sup>3</sup> density ensures high moisture resistance.

**Battiscopa in PVC espanso resistente all'umidità.**  
Moisture-resistant expanded PVC skirting board.

**Battiscopa realizzato con sistema folding utilizzando le relative doghe del pavimento.**  
Skirting board made with a folding system using the matching floor planks.

**Profilo per battiscopa realizzato in MDF rivestito di tranciato di vero legno con finiture verniciate a poro aperto (gruppo 1) e, per i colorati, con stampa digitale successivamente verniciato (gruppo 2).**  
Skirting board profile made of MDF and covered with real wood veneer. Two types of finishings available: open pore varnished finishing (group 1) and a coloured finishing made by digital printing process and then varnished (group 2).

**Profilo per battiscopa realizzato in MDF rivestito di tranciato di vero legno con finiture verniciate a poro aperto (gruppo 1) e, per i colorati, con stampa digitale successivamente verniciato (gruppo 2).**  
Skirting board profile made of MDF and covered with real wood veneer. Two types of finishings available: open pore varnished finishing (group 1) and a coloured finishing made by digital printing process and then varnished (group 2).

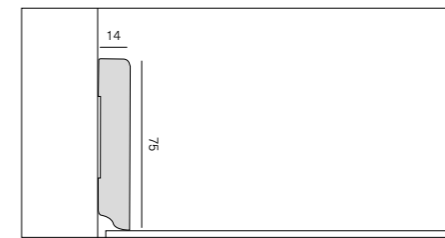
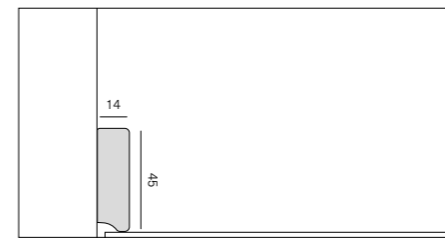
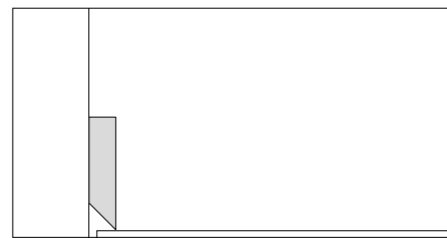
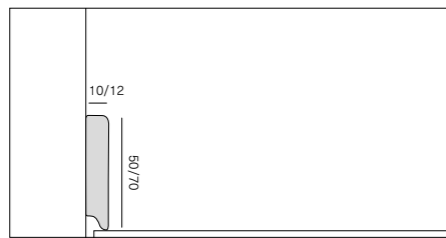
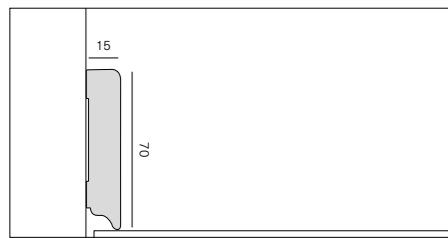

**ABACO / RECAP**

	<b>DROP</b>	<b>PVC ESPANSO</b>	<b>F</b>
<b>Abbinati</b> Matching	<b>K-Uno</b>	<b>Star K</b> <b>Star KR</b> <b>Star KC</b> <b>Star KD</b> <b>Connex</b>	<b>Yes</b>
<b>Abbinabili</b> Combined	-	<b>Star KS</b> <b>Star Wood</b> <b>Star Wood Spina</b>	-
<b>Tinta unita</b> Solid colors	○ <b>Bianco/ White - RAL 9003, 9010</b>	○ <b>Bianco/ White - RAL 9003, 9010</b> ● <b>Nero/ Black</b> ● <b>Alluminio/ Aluminum - RAL 9006</b>	-
<b>Dimensioni</b> Size	<b>h 70-2400x15 mm</b>	<b>h 50-2400x12 mm</b> <b>h 70-2400x12 mm</b>	<b>Variabile/ Variable</b>

**ABACO / RECAP**

	<b>W45</b>	<b>W75</b>
<b>Abbinabili</b> Combined	<b>Palladio</b> <b>Yes</b>	<b>Palladio</b> <b>Yes</b>
<b>Dimensioni</b> Size	<b>h 45-2400x14 mm</b>	<b>h 75-2400x14 mm</b>

# Profili

## Profiles

**PARAGRADINO ANTISDRUCCIOLO**  
NO-SLIP STAIR PROTECTOR



Paragradino antisdrucciolo in alluminio, che consente di rivestire il raccordo tra alzata e pedata di una scala.

**Acquistare sempre con antiscivolo autoadesivo.**  
Non-slip aluminum stair nosing, used to cover the transition between the riser and tread of a staircase. Always purchase with self-adhesive non-slip tape.

**ANGOLARE AD L**  
L-SHAPED CORNER PROFILE



Profilo in alluminio per finiture di raccordi a muro.  
Aluminium profile for finishing wall connections.

**PROFILO DI BORDO**  
BORDER PROFILE



Profilo in alluminio estruso per bordature perimetrali per pavimenti.  
Extruded aluminium profile for perimeter edging of floors.

**PROFILO DI BORDO CURVABILE**  
CURVABLE BORDER PROFILE



Profilo in alluminio estruso curvabile per bordature perimetrali.  
Extruded curvable aluminium profile for perimeter edging.

**TORO SCALA F**  
F STAIR NOSE



Toro scala realizzato con sistema folding utilizzando le relative doghe del pavimento, così da ottenere un perfetto abbinamento con lo stesso.  
**Verificare con ufficio tecnico la fattibilità nella finitura desiderata.**

Stair nose made with folding system using the same planks of the floor, in order to obtain a perfect match with the same. Check with the technical office the feasibility in the desired finish.

**TORO SCALA 30x30**  
STAIR NOSE 30x30



Toro scala in massello con spessori 10 mm e 15 mm; su richiesta il profilo può essere fornito anche stondato.

Solid wood stair bullnose with thicknesses of 10 mm and 15 mm; upon request, the profile can also be supplied with a rounded edge.

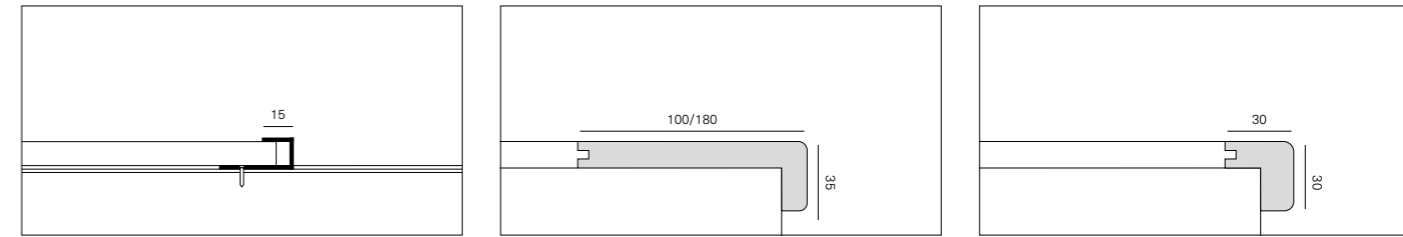
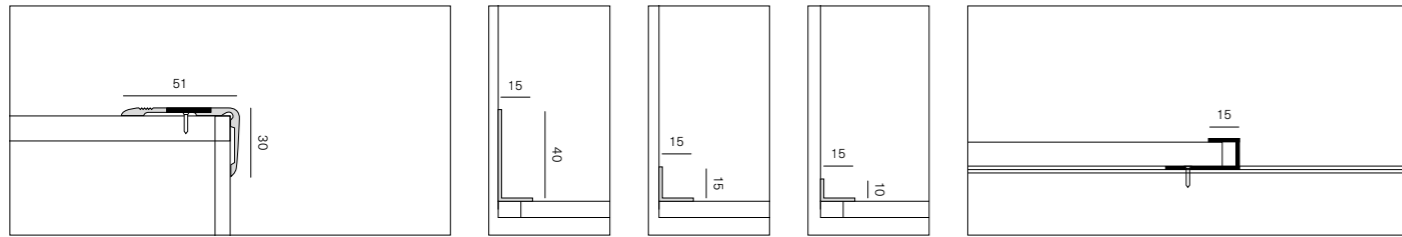

### ABACO / RECAP

	PARAGRADINO ANTISDRUCCIOLO NO-SLIP STAIR PROTECTOR	ANGOLARE AD L L-SHAPED CORNER PROFILE	PROFILO DI BORDO BORDER PROFILE
<b>Collezioni</b> Lines	Pavimenti tecnici/ Technical flooring SPC Legni/ Wood	Pavimenti tecnici/ Technical flooring SPC Legni/ Wood	Pavimenti tecnici/ Technical flooring SPC Legni/ Wood
<b>Tinta unita</b> Solid colors	● Argento anodizzato/ Anodized silver ● Oro anodizzato/ Anodized gold ● Bronzo anodizzato/ Anodized bronze	● Argento/ Silver ● Bronzo/ Bronze	● Argento/ Silver ● Oro/ Gold
<b>Dimensioni</b> Size	3400x52x30 mm  18 m rotolo striscia antiscivolo autoadesiva/ 18 m roll self-adhesive non-slip strip	● 2000/3000x15x10 mm spessore 1,0 mm/ 1.0 mm thick ● 2000x15x15 mm spessore 1,5 mm/ 1.5 mm thick ● 2000x45x40 mm spessore 2,0 mm/ 2.0 mm thick	2700x15x6 mm 2700x15x7 mm 2700x15x9 mm 2700x15x11 mm 2700x15x15 mm

### ABACO / RECAP

	PROFILO DI BORDO CURVABILE CURVABLE BORDER PROFILE	TORO SCALA F F STAIR NOSE	TORO SCALA 30x30 STAIR NOSE 30x30
<b>Collezioni</b> Lines	Pavimenti tecnici/ Technical flooring SPC Legni/ Wood	-	-
<b>Abbinabile</b> Combined	-	Palladio Yes	Palladio
<b>Tinta unita</b> Solid colors	● Argento/ Silver ● Oro/ Gold ● Bronzo/ Bronze	-	-
<b>Dimensioni</b> Size	Pavimenti tecnici/ Technical flooring ● 2700x15x9 mm - 2700x15x11 mm  SPC ● 2700x15x7 mm  Legni/ Wood ● 2700x15x11 mm ● 2700x15x13 mm - 2700x15x15 mm	Palladio 1850/2150x100/135/180x35 mm  Yes Variabile/ Variable	30x30x1200 mm

**TORO SCALA 100x30**  
STAIR NOSE 100x30



Toro scala in massello con spessori 10 mm e 15 mm; su richiesta il profilo può essere fornito anche stonato.

Solid wood stair bullnose with thicknesses of 10 mm and 15 mm; upon request, the profile can also be supplied with a rounded edge.

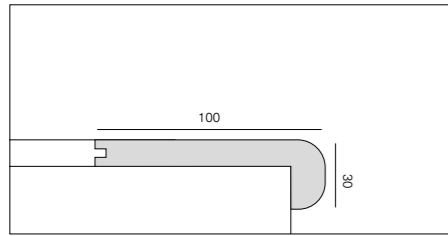

**KIT DILATAZIONE**  
EXPANSION KIT



Kit dilatazione abbinabile e in alluminio con Pin Unico per pavimenti con spessore da 9 a 15,5 mm, con base femmina in alluminio.

Aluminum expansion kit with Single Pin for floorings with thickness from 9 to 15,5 mm and aluminum female base.

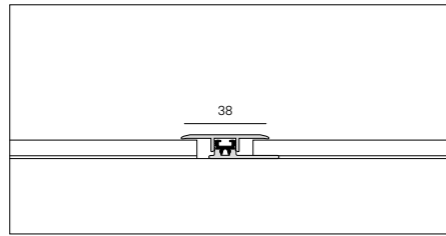

**KIT DISLIVELLO DA 9 A 15,5 MM**  
SPLICE KIT 9 TO 15,5 MM



Kit dislivello in alluminio con Pin Unico per pavimenti con spessore da 9 a 15,5 mm con base femmina in alluminio.

Aluminium transition kit with Single Pin for floors with thickness from 9 to 15.5 mm, with aluminium female base.

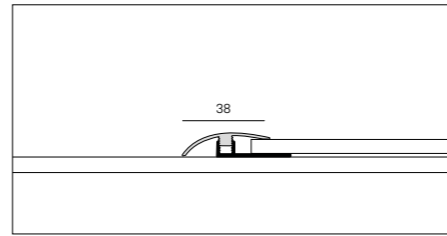

**KIT TERMINALE**  
TERMINAL KIT



Kit terminale in alluminio con Pin Unico per pavimenti con spessore da 9 a 15,5 mm con base femmina in alluminio.

Aluminium end kit with Single Pin for floors with thickness from 9 to 15.5 mm, with aluminium female base.

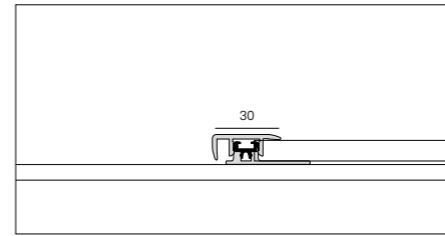

**CLIP DI AGGANCIO**  
RETAINING CLIP



Clip di aggancio in metallo zincato nero che, con rotazione sull'omega, fissa pannelli e doghe alla struttura.

Black galvanized metal clip that, by rotating onto the omega, secures panels and slats to the structure.

**ABACO / RECAP**

	<b>TORO SCALA 100x30</b> STAIR NOSE 100x30	<b>KIT DILATAZIONE</b> EXPANSION KIT	<b>KIT DISLIVELLO DA 9 A 15,5 MM</b> SPLICE KIT 9 TO 15,5 MM
<b>Collezioni</b> Lines	-	<b>Pavimenti tecnici/</b> Technical flooring <b>Legni/</b> Wood	
<b>Abbinati</b> Matching	-	<b>K-Uno</b> <b>Prestige L</b> <b>Prestige Gold</b> <b>Facile+</b> <b>Vision Oxid</b> <b>Vision Technic</b> <b>Lumbertech</b>	<b>Pavimenti tecnici/</b> Technical flooring
<b>Abbinabili</b> Combined	<b>Palladio</b>	<b>Syncro Parquet</b>	-
<b>Tinta unita</b> Solid colors	-	● <b>Argento anodizzato/</b> Anodized silver	● <b>Argento anodizzato/</b> Anodized silver
<b>Dimensioni</b> Size	<b>100x30x1200 mm</b>	<b>2700x38 mm</b>	<b>2700x38 mm</b> <b>2700x45 mm</b>

**ABACO / RECAP**

	<b>KIT TERMINALE</b> TERMINAL KIT	<b>CLIP DI AGGANCIO</b> RETAINING CLIP
<b>Collezioni</b> Lines	<b>Pavimenti tecnici/</b> Technical flooring <b>Legni/</b> Wood	<b>K-Uno</b> <b>Prestige L</b> <b>Lumbertech</b>
<b>Tinta unita</b> Solid colors	● <b>Argento/</b> Silver	-
<b>Dimensioni</b> Size	<b>2700x30 mm</b>	<b>44x41 mm</b>
<b>Confezione</b> Packaging	-	<b>200 pz/ pcs</b>

# Accessori per rivestimenti a parete e soffitto

## Accessories for wall and ceiling coverings

### PROFILO OMEGA OMEGA PROFILE



Il profilo ad omega costituisce l'elemento per il fissaggio a parete tramite viti o tasselli e deve essere montato ad una struttura portante tipo cartongesso o al muro da rivestire.

Omega cross-section profile is the element that fastens the boards to the wall. It must be installed using screws or wall plugs to a load bearing structure, such as drywall or the wall to be covered.

Dimensioni  
Size

	3000x25x26 mm
	3000x13x26 mm

# Posa Laying

### KIT MORSETTI TELESCOPICI TELESCOPIC CLAMP KIT



In fase di partenza il muro non è mai regolare. I morsetti permettono di registrare la distanza tra muro e pavimento in senso longitudinale, accelerando le fasi di posa di un pavimento flottante. Consigliati 2 kit per posatore.

When starting, walls are never perfect. These clamps allow you to register the horizontal distance between the wall and the flooring, for more rapid installation.

2 kits per installer are recommended.

Collezioni  
Lines

	Pavimenti tecnici/ Technical flooring
	Legni/ Wood

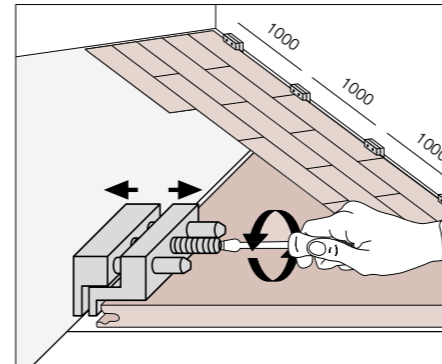

### GRIMALDELLO PICKLOCK



È indispensabile per completare l'ultima fila di pavimento, in quanto non c'è spazio per la manovra del martello. Solo per incastri SLS e PLS (no TLS). Consigliato 1 pezzo per posatore.

This tool is required for finishing the last row of the flooring as there is no place enough for using the hammer.

We recommend 1 tool per installer.

Collezioni  
Lines

	Pavimenti tecnici/ Technical flooring
	Legni/ Wood

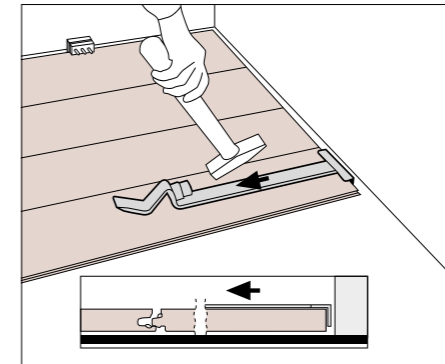

### TENSIONATORE CINGHIA BELT TENSIONER



Per pavimenti con incastro a colla. Strumento per compattare le prime tre/ quattro file di doghe, fondamentali per la buona riuscita del lavoro soprattutto con colori chiari su incastri tradizionali a colla. Consigliati 6 pezzi per posatore.

For floorings with glued joints. Used to compact the first three or four rows of planks. Fundamental for good installation, especially for light colours with traditional glued joints.

6 units per installer are recommended.

Collezioni  
Lines

	Pavimenti tecnici/ Technical flooring
	Legni/ Wood

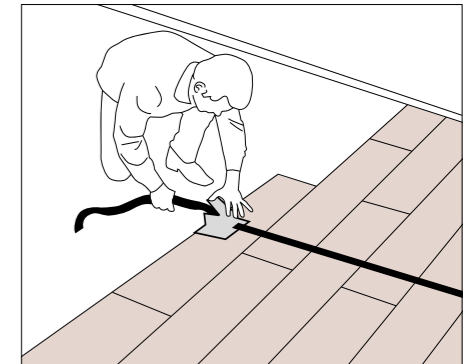

**DISTANZIATORE PER PAVIMENTI FLOTTANTI**  
SPACER FOR FLOATING FLOORING



Nei casi in cui si debba fissare al pavimento elementi di arredo o funzionali, consente di evitare il bloccaggio delle dilatazioni del pavimento e conseguenti sollevamenti dello stesso.  
If you need to fasten pieces of furniture or functional elements to the flooring, it avoids blocking the flooring expansion and its consequent raising.

**DISTANZIATORE PER PAVIMENTI AV2**  
AV2 SPACER FOR FLOORING



Distanziatore in plastica per pavimenti flottanti, regolabile 5–20 mm.  
Plastic spacer for floating floors, adjustable 5–20 mm.

**BATTITAVOLA PAVIMENTI TECNICI**  
TECHNICAL FLOORING STAVES ALIGNER



Indispensabile per raccordare le doghe. Consigliato 1 pezzo per posatore.  
**Avvertenza: Usare esclusivamente battitavola originali per evitare di danneggiare l'incastro in modo irreparabile.**  
Indispensable for aligning the edge of the panels. We recommend 1 tool per installer.  
Notice: Use only original Staves Aligner to avoid irreparable damages to the joint.

**COLLA NUNIVIL 1008 (D3)**  
GLUE NUNIVIL 1008 (D3)



Adesivo acetovinilico per pavimenti flottanti con incastro M/F. Consumo medio 35–40 g/m<sup>2</sup>.  
**Consultare la documentazione tecnica sul sito.**  
Special vinyl adhesive for floating floors with M/F joint. Average consumption 35–40 g/m<sup>2</sup>.  
Refer to the technical documentation on the website.

**COLLA ISOCOLL 6307 BEIGE PER BATTISCOPA PVC ESPANSO**  
GLUE ISOCOLL 6307 BEIGE FOR EXPANDED PVC SKIRTING BOARDS



Colla poliuretanica monocomponente per un ottimo fissaggio del battiscopa in PVC espanso su diverse superfici.  
Single component polyurethane adhesive for excellent fastening of expanded PVC skirting board on different surfaces.

**COLLA ISOCOLL ECO 6056 BIANCO PER SCALE BATTISCOPA**  
GLUE ISOCOLL ECO 6056 WHITE FOR STEPS AND SKIRTING BOARDS



Colla monocomponente per il fissaggio del battiscopa e incollaggio gradini.  
Single component adhesive for fastening skirting and stair elements.

Collezioni Lines Pavimenti tecnici/ Technical flooring

Collezioni Lines Pavimenti tecnici/ Technical flooring Legni/ Wood

Collezioni Lines Pavimenti tecnici/ Technical flooring

Collezioni Lines Pavimenti tecnici/ Technical flooring Legni/ Wood

Collezioni Lines SPC

Collezioni Lines Pavimenti tecnici/ Technical flooring Legni/ Wood

Confezione Packaging 500 gr

Confezione Packaging 290 ml

Confezione Packaging 290 ml

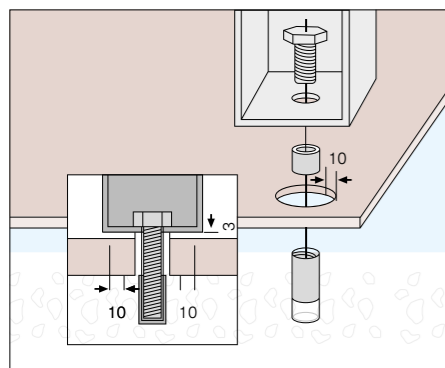

**ACCESSORI DI MONTAGGIO**  
INSTALLATION ACCESSORIES



Accessori complementari utili per un lavoro preciso e veloce.  
Accessories complementary for accurate, rapid installation.

Collezioni Lines Pavimenti tecnici/ Technical flooring

# Cura e manutenzione

## Care and maintenance

### PULISYSTEM



**Detergente igienizzante.**  
Sanitizing detergent.

Collezioni  
Lines

Pavimenti tecnici/  
Technical flooring  
Lumbertech  
SPC

Confezione  
Packaging

1 L

### SANITOTAL



**Detergente decontaminante.**  
**Attenzione: da utilizzarsi dopo aver lavato le superfici con il prodotto pulisystem.**  
Decontaminant detergent.  
Warning: use only after cleaning surfaces with Pulisystem.

Collezioni  
Lines

Pavimenti tecnici/  
Technical flooring  
Lumbertech  
SPC

Confezione  
Packaging

1 L

### MULTILAYER CLEANER



**Detergente antistatico sanificante adatto alla pulizia di pavimenti tecnici e vinilici.**  
Antistatic sanitizing cleaner for technical and vinyl flooring.

Collezioni  
Lines

Pavimenti tecnici/  
Technical flooring  
Lumbertech  
SPC

Confezione  
Packaging

1 L

### OLIO PER RITOCOCCO RETOUCHING OIL



**Olio per ritocco e ripristino.**  
Touch-up and restoration oil.

Collezioni  
Lines

Lumbertech 270 Oil

Confezione  
Packaging

0,125 L

### CLEANER STAR



**Detergente intensivo multiuso per la pulizia di pavimenti in legno verniciati/ olio UV.**  
Intensive multipurpose cleaner for varnished and UV-oiled wooden floors.

Collezioni  
Lines

Lumbertech 270  
Varnish, 205, S700  
Palladio

Confezione  
Packaging

-

### OSMO POLYX OIL 3062 MATT



**Trattamento speciale di oliatura.**  
Special oiling treatment.

Collezioni  
Lines

Lumbertech 270 Oil

Confezione  
Packaging

-

### WAX CARE SPRAY



**Waxe care è una dispersione di cere idrorepellenti per la protezione di pavimenti in legno verniciati o oliati.**

Waxe care is a dispersion of water-repellent waxes for protection of varnished or oiled wooden floors.

Collezioni  
Lines

Star Wood  
Star Wood Spina  
Legni/ Wood

Confezione  
Packaging

-

### PARKETTREINIGER



**Detergente per parquet a base di sapone naturale, pH neutro, ideale per la pulizia periodica di pavimenti in legno verniciati o oliati.**

Parquet cleaner, natural soap-based, pH-neutral, ideal for regular cleaning of varnished or oiled wooden floors.

Collezioni  
Lines

Lumbertech 270 Oil  
Palladio  
Yes

Confezione  
Packaging

1 L

### DETERGENTE MANUTENTORE CEROSO WAXY MAINTENANCE CLEANER



**Prodotto di manutenzione trasparente a base di cere naturali per il rinnovo ciclico dei pavimenti in legno.**

Transparent maintenance product based on natural waxes for the cyclical renewal of wooden floors.

Collezioni  
Lines

Lumbertech 270 Oil  
Palladio  
Yes

Confezione  
Packaging

1 L

**PACKAGING  
E LOGISTICA**  
PACKAGING  
AND LOGISTICS

# Pavimenti in legno

## Wood flooring

Prodotto Product	Rif. formato mm Size mm	Pezzi Cfz Pieces Box	m <sup>2</sup> Cfz m <sup>2</sup> Box	Dimensioni scatola mm Box dimensions mm	Kg per scatola Kg per box	Cfz pallet Box pallet	m <sup>2</sup> pallet m <sup>2</sup> pallet	Dimensione pallet (mm) Pallet dimensions (mm)	Kg pallet al m <sup>2</sup> Pallet kg per m <sup>2</sup>	Peso lordo pallet Pallet Weight
PALLADIO	1850/2150/2350 x192x15	4	VAR	VAR	VAR	50	VAR	1870/2170/2370 x1000x750	8,39	VAR
	1850x2150x152x11	8	VAR	VAR	VAR	36	VAR	1870x2170x960x680	6,27	VAR
	650x120x15	10 (5dx+5sx)	0,988	665x162x150	6,195	28	VAR	670x1100x750	6,67	VAR
VILLA	2200x180x14	7	2,772	2215x190x105	22	25	69,3	2220x970x660	8,08	577
	1092x130x10	9	1,278	1157x140x100	7,8	49	62,6	1130x1050x830	6,34	412
	660x110x14	8 (4dx+4sx)	0,581	675x115x115	4,69	56	32,536	950x700x950	8,08	282
	550x110x14	8 (4dx+4sx)	0,484	690x125x115	3,91	56	27,104	1000x710x970	8,08	239
LUMBERTECH 270	2200x270x11	4	2,376	2235x295x49	23,46	30	71,28	2250x900x480	9,87	719
LUMBERTECH S700	700x140x11	10	0,98	730x160x120	10,36	56	54,88	1200x760x900	8,9	559
LUMBERTECH 205	2200x205x11	4	1,804	2230x210x50	20	40	72,16	2250x920x570	11,12	790

**Skema S.p.A.**

Via dell'Artigianato, 8  
31047 Ponte di Piave (TV) - Italy

Ph. (+39) 0422 858511  
info@skema.eu  
www.skema.eu

**A.D.**

arch. paolo pampanoni

**Concept & Graphic**

d+a srl

**Set design, rendering**

virtual design  
nudesign srl

**Photo**

studio antiorario

**Printed**

grafiche antiga

La riproduzione dei colori è approssimativa.

Skema S.p.A. ha la facoltà esclusiva di modificare e sostituire, anche solo parzialmente, i componenti dei sistemi illustrati in questo folder, senza l'obbligo di darne preavviso.

The reproduction of colors is approximate. Skema S.p.A. has the exclusive right to modify and replace, even only partially, the components of the systems illustrated in this folder, without the obligation to give prior notice.

© Copyright by Skema S.p.A.  
All rights reserved

