

Unique pools

Sports Pools | 2023

by  ROSA
GRES

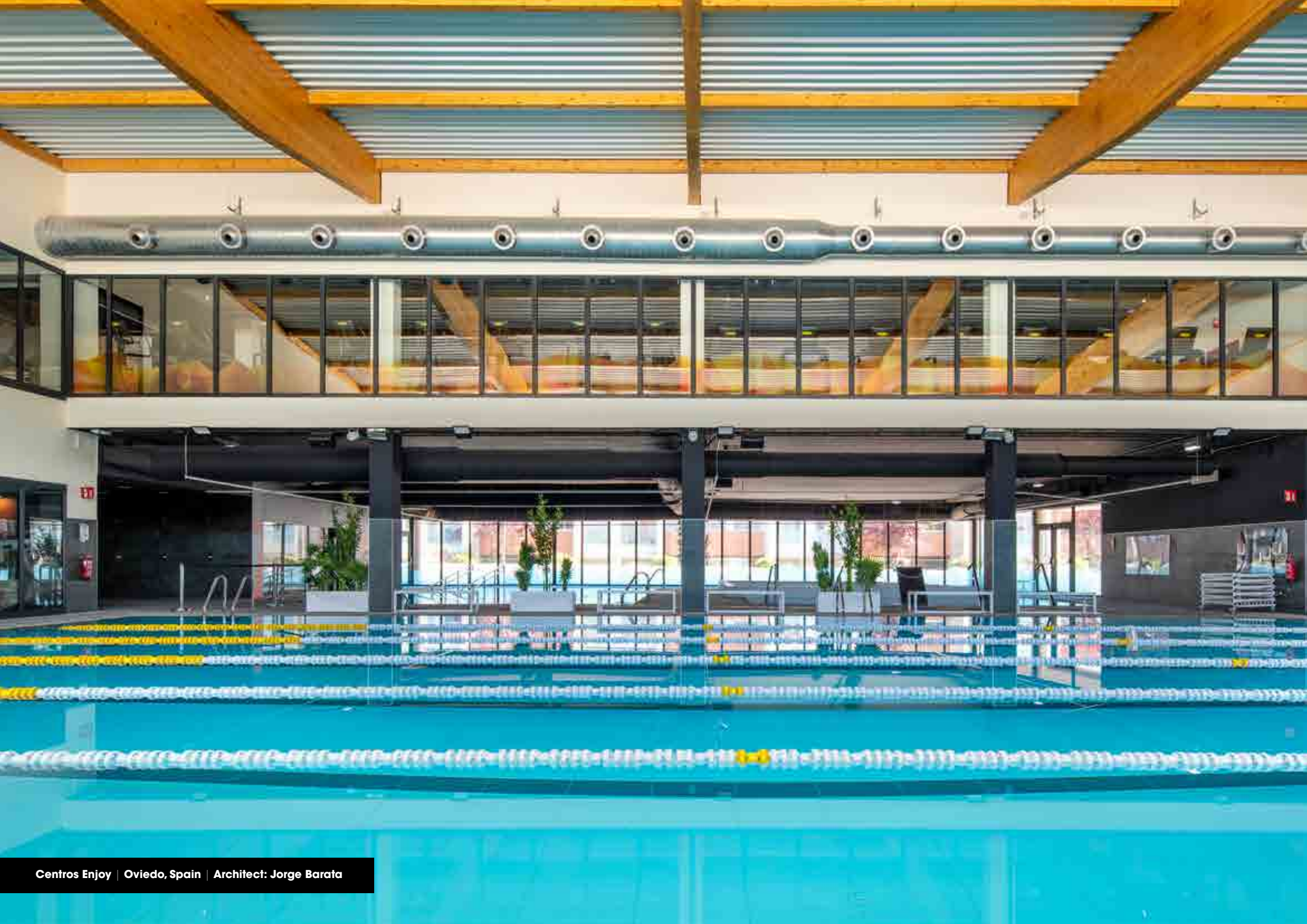



En **Rosa Gres** como fabricantes de **gres porcelánico**. Contamos con más de 50 años de experiencia y proyectos realizados en todo el mundo. **Sports Pools**, es nuestro catálogo dedicado a la piscina deportiva y de competición.

En esta edición, te presentamos los nuevos colores del acabado **Pastilla**, nuestro **antideslizante** más seguro y confortable. Además, encontrarás nuestra selección de **sistemas constructivos**, la colección **Aqua**, diseñada para la piscina deportiva, una completa gama de piezas especiales y nuestro gres porcelánico **anti-bacterias**, ideal para vestuarios. Y por supuesto, todos los colores **Rosa Gres**.

Como siempre, puedes contar con nuestro **equipo técnico** experto en piscinas. Te asesoraremos y podrás disfrutar de recreaciones detalladas de tu proyecto con tecnología **BIM**.

¡Gracias por estar aquí!

Rosa Gres is a **porcelain stoneware** manufacturing company. We have more than 50 years of experience and projects all over the world. **Sports Pools** is our catalogue dedicated to sports and competition pools.

In this edition, we present the new colors available for the **Pastilla** finish, our safest and most comfortable **anti-slip** surface. It also includes our different **construction systems**; the **Aqua** collection, designed especially for sports pools; a complete range of trim pieces; and our **antibacterial** porcelain stoneware, ideal for changing rooms. And, of course, the full range of **Rosa Gres** colors.

As always, you can count on the expertise of our team of **technicians** who specialize in swimming pools. We will be happy to advise you, and you will be able to enjoy detailed recreations of your project made using **BIM** technology.

Thank you for being here!

Rosa Gres est un fabricant de **grès cérame**. Nous avons plus de 50 ans d'expérience et nous réalisons des projets dans le monde entier. **Sports Pools** est notre catalogue spécialisé dans les piscines sportives et de compétition.

Dans cette édition, nous vous présentons les nouveaux coloris de notre finition de revêtement **Pastilla**, notre **anti-dérapant** le plus sûr et le plus agréable. Vous trouverez également dans ce catalogue notre sélection de **systèmes de construction**, ainsi que la collection **Aqua**, conçue pour les piscines sportives, plus une gamme complète de pièces spéciales et notre grès cérame **antibactérien**, idéal pour les vestiaires. Sans oublier bien sûr tous les coloris de **Rosa Gres**.

Comme toujours, vous pouvez compter sur notre équipe technique spécialiste des piscines. Nous vous conseillons et vous proposons des simulations détaillées de votre projet grâce à la technologie **BIM**.

Merci de nous suivre !

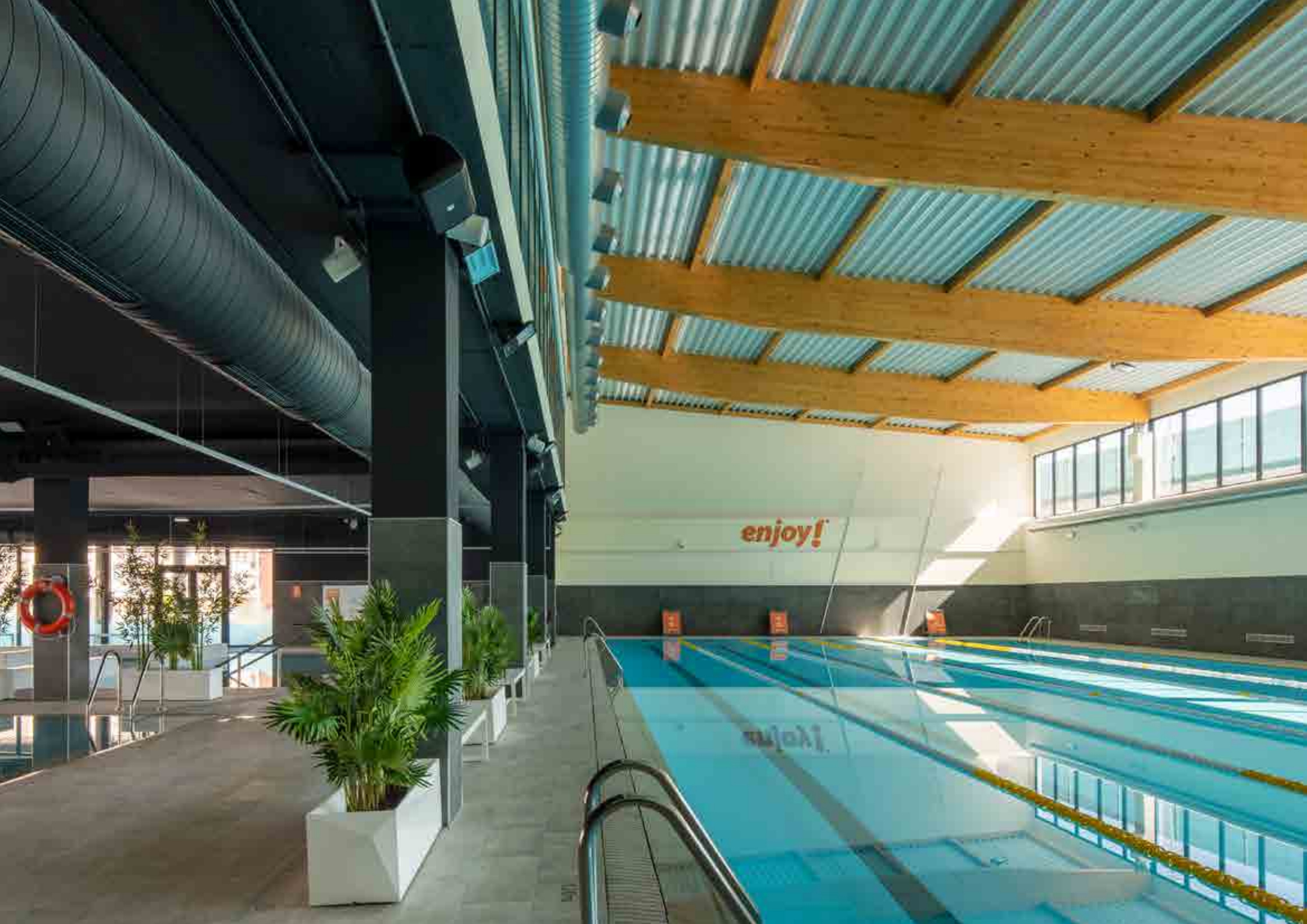

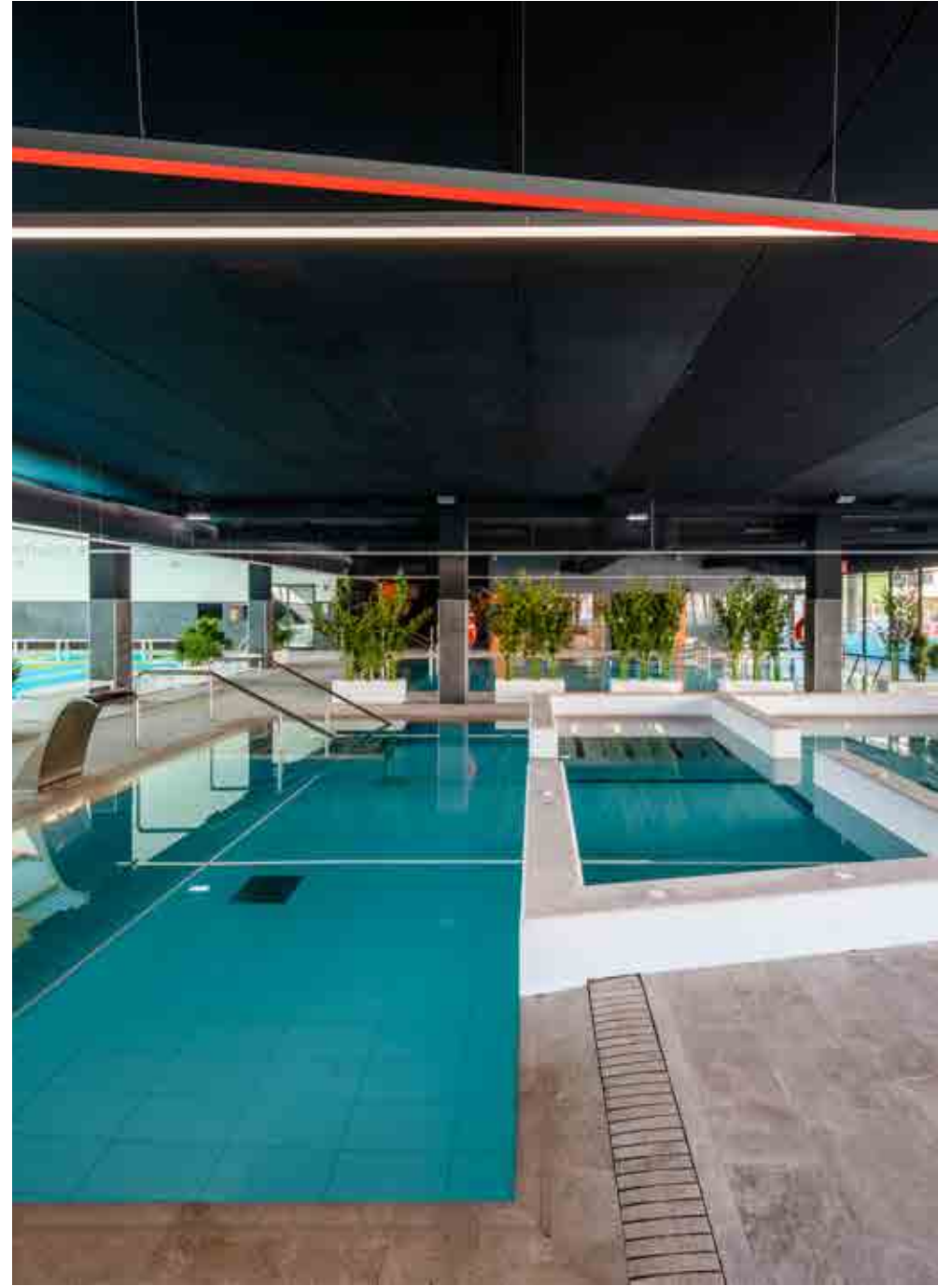

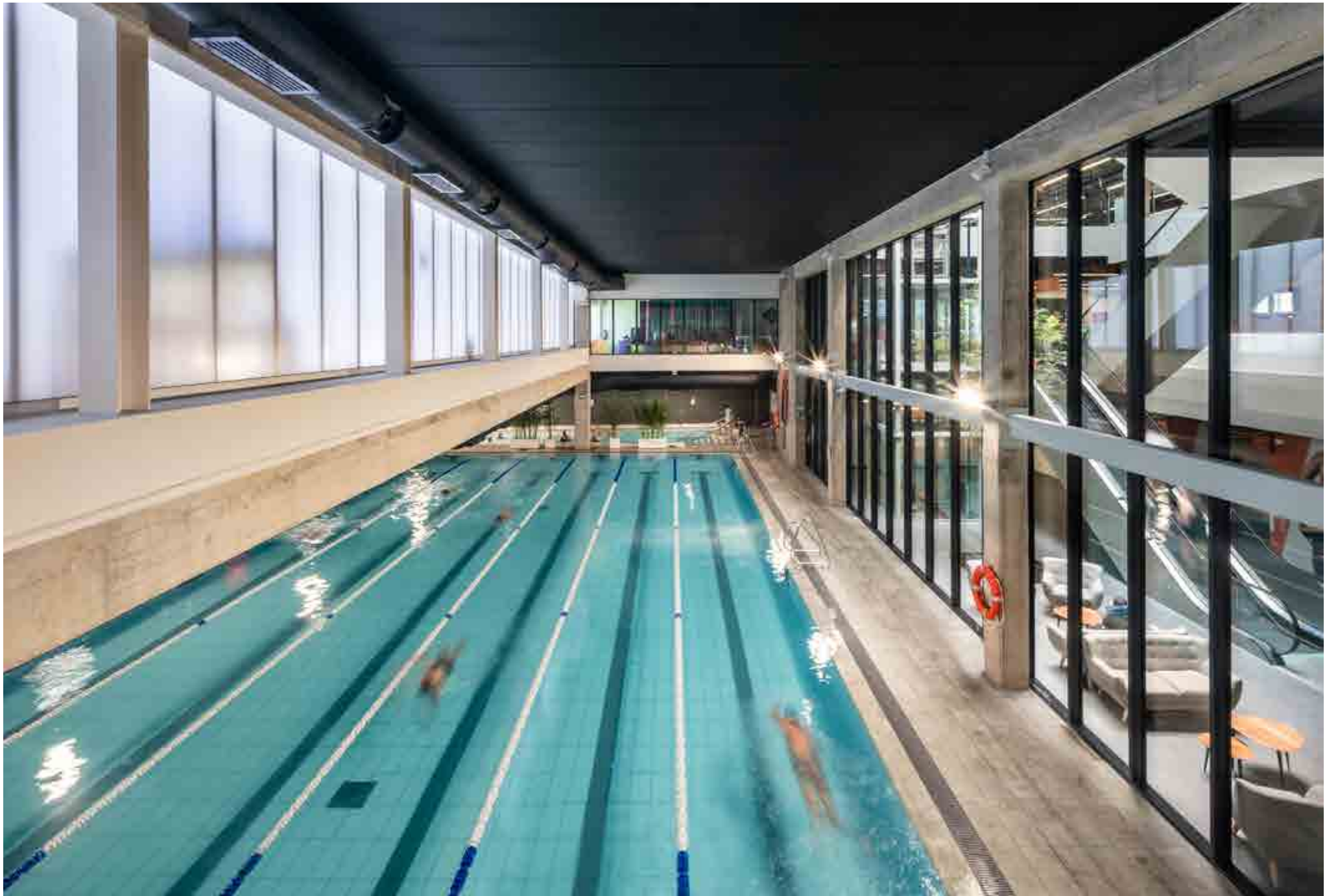





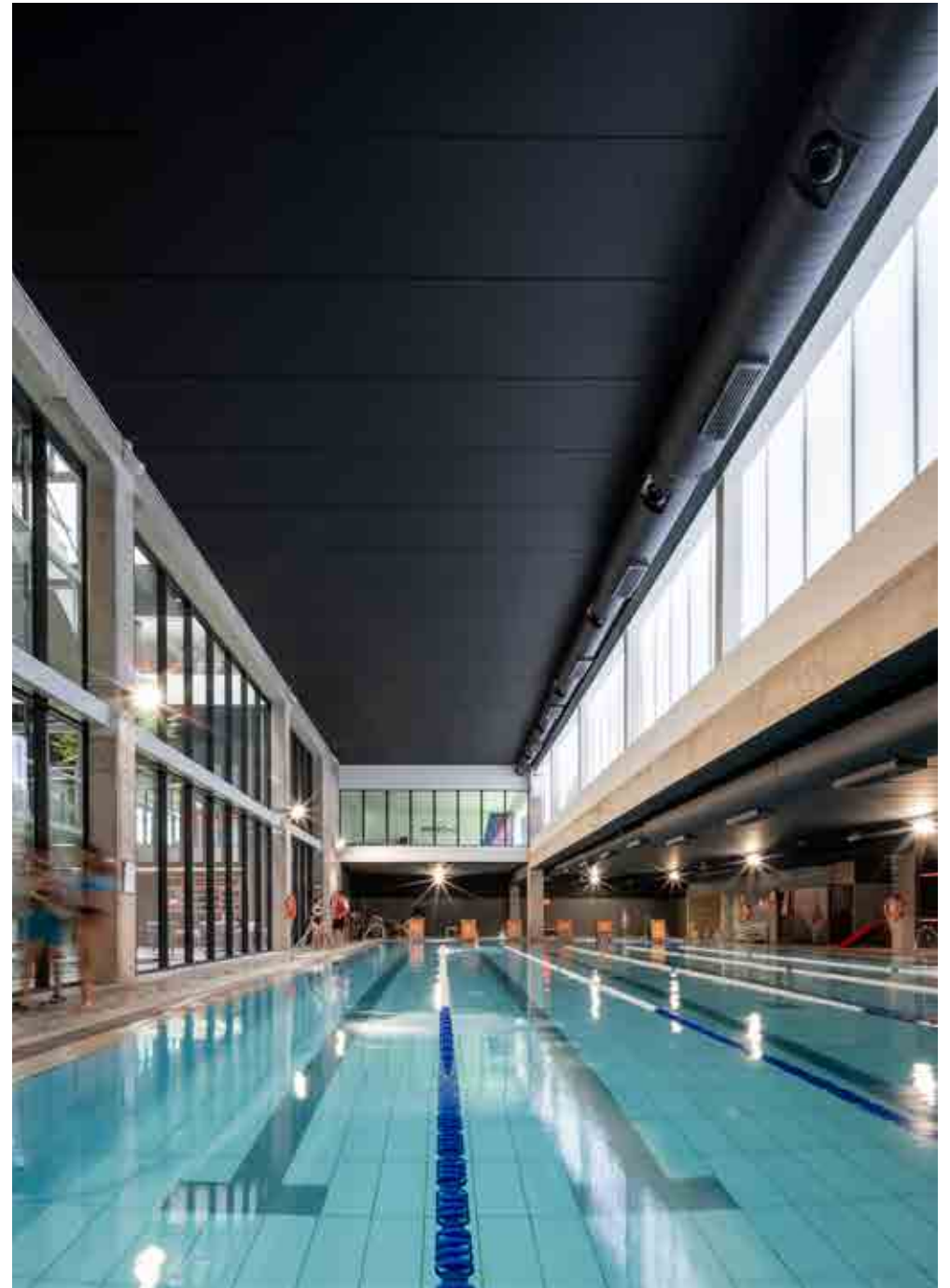











100m



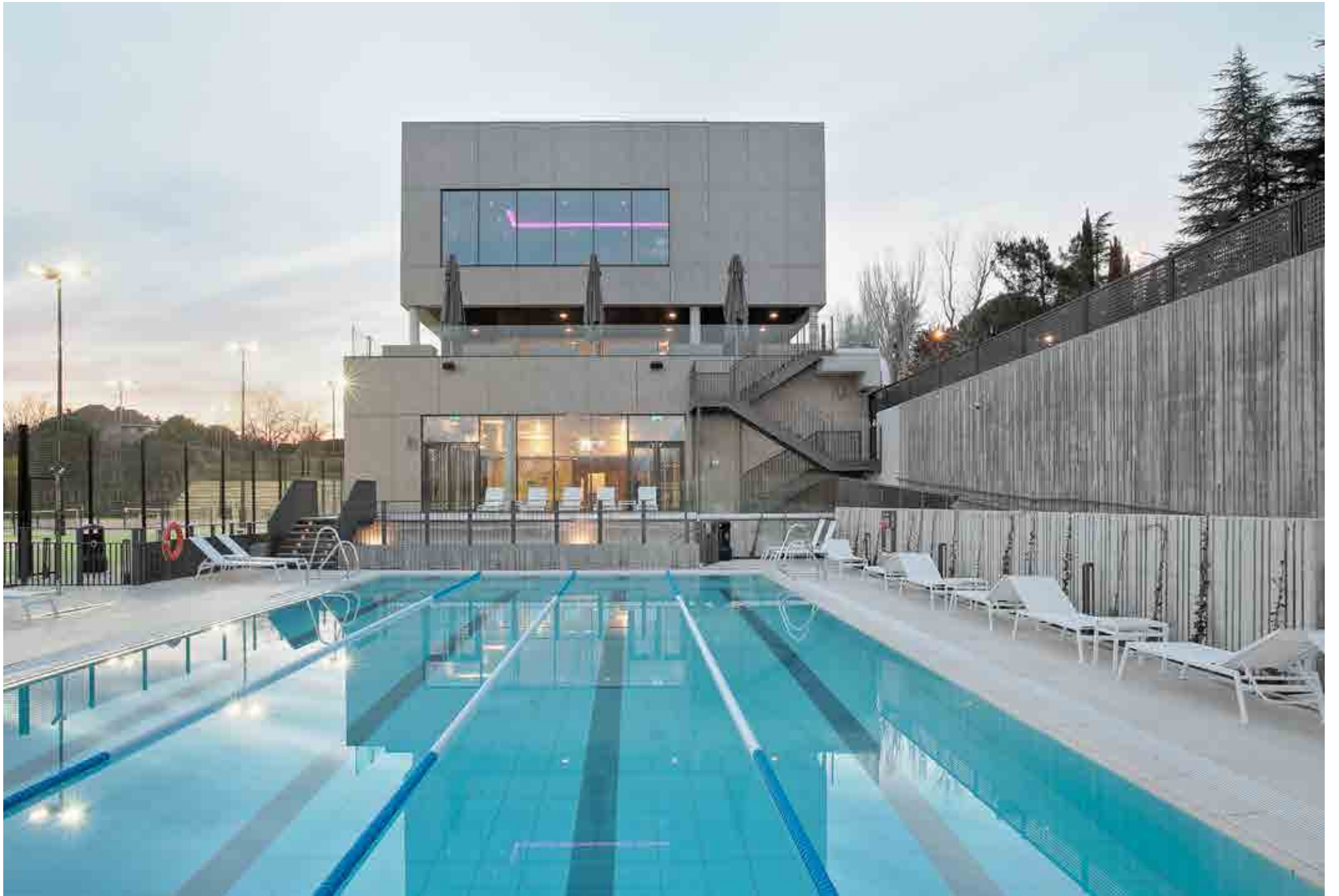











Aqua

EN 16165

ANTI-SLIP



CLASE 3

CLASE C

PN24

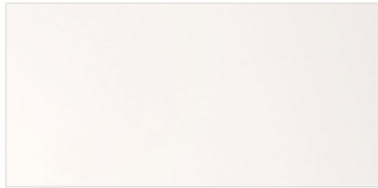

Blanco



Azul



Marino



Plomo



Prusia



Habana



Oliva



Amarillo



Rojo N



244 G1
liso | smooth | lisse
24,4 x 49,4 x 0,8



244 G1
anti-slip
24,4 x 49,4 x 0,8



122 G1
liso | smooth | lisse
11,9 x 24,4 x 0,8



122 G1
anti-slip
11,9 x 24,4 x 0,8



052 G1
liso | smooth | lisse
5,6 x 24,4 x 0,8

Mosaic

Mosaico vítreo | Vitreous mosaic | Mosaïque vitrée

EN 16165

ANTI-SLIP

UNE 41901

DIN 51097

XP P-05-010



CLASE 3



CLASE C



PN24

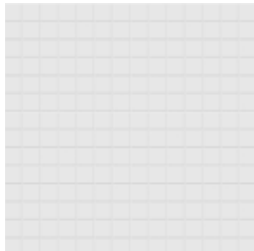

Mosaic Blanco

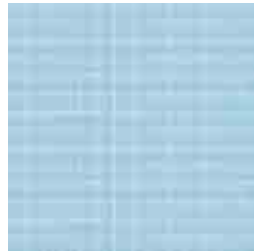

Mosaic Azul

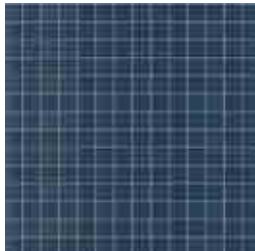

Mosaic Marino



Mosaic Plomo



Mosaic Ivory

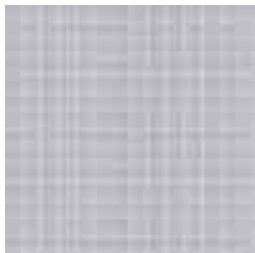

Mosaic Perla

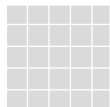

320
liso | smooth | lisse
33 x 33 x 0,5
2,3 x 2,3 / u

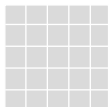

320
anti-slip
33 x 33 x 0,5
2,3 x 2,3 / u

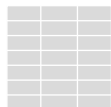

323
liso | smooth | lisse
33 x 33 x 0,5
2,3 x 4,6 / u

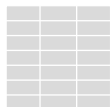

323
anti-slip
33 x 33 x 0,5
2,3 x 4,6 / u





Aqua

EN 16165



Plomo Pastilla



Indubeige Pastilla



240 G1
Pastilla
24,4 x 24,4 x 0,8

Pietro

EN 16165



Pietro White Pastilla



Pietro Golden Pastilla



Pietro Grey Pastilla



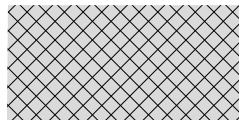

Pietro Dark Pastilla



Pastilla
31 x 62,6 x 0,9

Iconic

EN 16165

DIN 51097	DIN 51130	UNE 41901	DIN 51130
 CLASE C	R11 >19° - 27°	 CLASE 3	V4



Iconic White Pastilla



Iconic Grey Pastilla



Iconic Dark Pastilla

Estas piezas se pueden combinar con otra pieza del mismo color en acabado anti-slip. (ver página 26).

These pieces can be combined with another piece of the same colour in anti-slip finish (see page 26).

Ces pièces peuvent être combinées avec une autre pièce de la même couleur en finition antidérapante (voir page 26).

MAXIMUM SAFETY

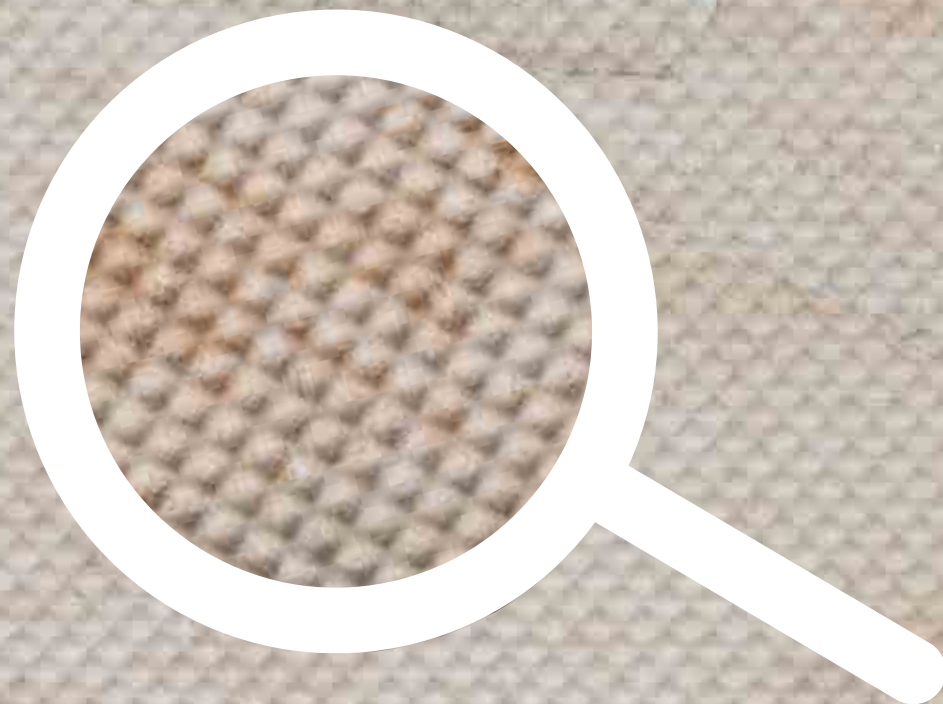

trésor

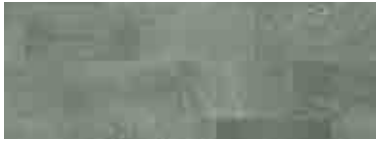

Trésor Bali



Trésor Java

mythos



Mythos Selene



Mythos Dune



Mythos Antique

iconic



Iconic White

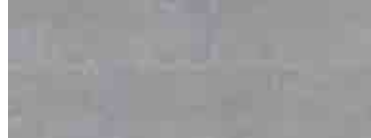

Iconic Grey



Iconic Dark

pietro *♥ mix*



Pietro White



Pietro Golden



Pietro Grey



Pietro Dark

stela *♥ mix*



Stela White



Stela Golden



Stela Grey



Stela Dark

316
anti-slip
31 x 62,6 x 0,9

***310 BH**
anti-slip
31,3 x 31,3

50M
anti-slip
48,8 x 97,9 x 1

50M
liso / smooth / lisse
48,8 x 97,9 x 1

316
anti-slip
31 x 62,6 x 0,9

50M
anti-slip
48,8 x 97,9 x 1

50M
liso | smooth | lisse
48,8 x 97,9 x 1

316
anti-slip
31 x 62,6 x 0,9

316
Pastilla
31 x 62,6 x 0,9

50M
anti-slip
48,8 x 97,9 x 1

316
anti-slip
31 x 62,6 x 0,9

316
Pastilla
31 x 62,6 x 0,9

199
anti-slip
19,4 x 97,9 x 1

199
liso | smooth | lisse
19,4 x 97,9 x 1

* Mosaico enmallado en gres porcelánico | Mesh-mounted porcelain mosaic tiles | Mosaïque en grès cérame

alma



Alma Pure



Alma Honey



Alma Forest



Alma Mist

199
anti-slip
19,4 x 97,9 x 1

199
liso | smooth | lisse
19,4 x 97,9 x 1

mystery



Mystery White



Mystery Sand



Mystery Grey



Mystery Blue Stone

50M
anti-slip
48,8 x 97,9 x 1

50M
liso | smooth | lisse
48,8 x 97,9 x 1

316
anti-slip
31 x 62,6 x 0,9

316
liso | smooth | lisse
31 x 62,6 x 0,9

***310 BH**
liso | smooth | lisse
31,3 x 31,3

serena



Serena Bianco



Serena Ocra



Serena Griggio



Serena Nero



Serena Mix

316
anti-slip
31 x 62,6 x 0,9



Para más información
descárgate el catálogo
Unique Pools Hotel & Spa

For more information, download
the **Unique Pools Hotel & Spa**
catalogue

Pour plus d'informations,
téléchargez le catalogue
Unique Pools Hotel & Spa



Indugres



Piscine & Spa de Gujan | Mestras, Francia



Bio-Cerpoxi White
21 KG/U

Bio-Cerpoxi Grey
21 KG/U

Junta de colocación

100% Biostop

Mortero coloreado epoxi con resistencia al ataque de los ácidos y propiedades protectoras: previene el crecimiento de microorganismos perjudiciales para la salud.

Grout Joints

100% Biostop

Coloured epoxy resin resistant to acid and with protective properties: prevents the growth of harmful microorganisms.

Mortier de Jointoiement

100% Biostop

Mortier coloré époxy résistant aux agressions acides et présentant des propriétés protectrices pour empêcher le développement de microorganismes nocifs pour la santé.

Formatos | Formats | Formats

EN 16165

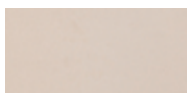
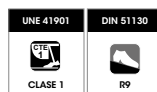

11,9 x 24,4 x 1
Indubeige R9

EN 16165

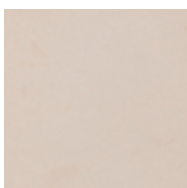

24,4 x 24,4 x 1
Indubeige R10

EN 16165

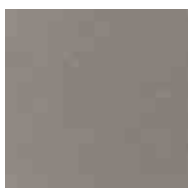

24,4 x 24,4 x 1
Indugrey R10

EN 16165

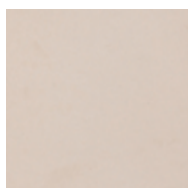

24,4 x 24,4 x 1
Indubeige R12

EN 16165

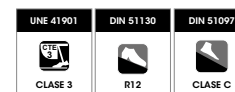

24,4 x 24,4 x 1
Indugrey R12

122 G3
11,9 x 24,4 x 1

240 G3
24,4 x 24,4 x 1

Revestimiento | Wall tiles | Revêtement

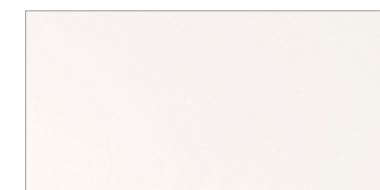

Bio White
liso | smooth | lisse



244 G1
24,4 x 49,4 x 0,8



La cerámica que elimina las bacterias

La única solución de autoprotección total.
Gres Porcelánico + Junta de Colocación



Funciona 24 h en interiores y exteriores

Funciona con luz artificial, con luz natural y en completa oscuridad.



Autoprotección total y permanente

La acción auto protectora es permanente y 100% segura. No necesita ningún tratamiento posterior ni mantenimiento para funcionar.



Eficacia probada contra las bacterias

Evita al 100% la proliferación de bacterias como: **Staphylococcus Aureus, Escherichia Coli, Proteus Vulgaris, Salmonella typhi, Enterococcus Faecalis, Streptococcus Pyogenes, Bacillus** o **Listeria Monocytogenes**



Es gres porcelánico industrial Rosa gres de alta calidad

Su proceso de fabricación garantiza que todas las propiedades del gres porcelánico industrial Rosa Gres se mantienen intactas.



No es tóxico para la salud

Es totalmente inocuo para la salud humana.



Reduce los olores

Evita los malos olores que pueda provocar los depósitos de microorganismos en las superficies.

Ceramic tile that eliminates bacteria

The only total self-protection solution: porcelain ceramic tile and sealing grout

Works 24 hours indoors and outdoors.

Works in artificial light, natural light and total darkness.

Total and permanent self-protection.

Self-protection is permanent and 100% safe. It does not require any treatment or maintenance.

Proven efficacy against bacteria.

Prevents 100% of bacteria growth such as: **Staphylococcus Aureus, Escherichia Coli, Proteus Vulgaris, Salmonella Typhi, Enterococcus Faecalis, Streptococcus Pyogenes, Bacillus** and **Listeria Monocytogenes**.

Rosa Gres high-quality industrial porcelain stoneware. The manufacturing process guarantees that all the properties of Rosa Gres industrial porcelain stoneware are maintained.

Not toxic to health.

Completely harmless to human health.

Reduces odors.

Prevents unpleasant odors caused by the accumulation of microorganisms on surfaces.

La cerámica que elimina las bacterias

La solución exclusiva d'auto-protección total: grès cérame et joint de pose

Fonctionne 24 heures à l'intérieur et à l'extérieur

Il Fonctionne à la lumière artificielle, à la lumière naturelle et dans l'obscurité totale.

Auto-protection totale et permanente

L'action auto-protectrice est permanente et sûre à 100%. Aucun post-traitement ou entretien n'est nécessaire pour fonctionner.

Efficacité prouvée contre les bactéries

Évite à 100% la prolifération de bactéries telles que : **Staphylococcus aureus, Escherichia coli, Proteus Vulgaris, Salmonella Typhi, Enterococcus faecalis, Streptococcus pyogenes, Bacillus, Listeria monocytogenes**

Grès cérame porcelaine industriel de haute qualité

Son processus de fabrication garantit que toutes les propriétés du grès cérame industriel Rosa Gres restent intactes.

Non toxique pour la santé

Totalement inoffensif pour la santé.

Réduit les odeurs

Évite les odeurs désagréables causées par les dépôts de microorganismes sur les surfaces.

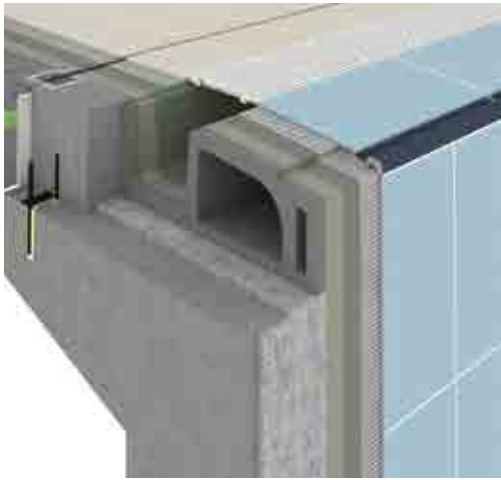

Horyzon



Finlandés
Finnish
Finlandais



Ergo

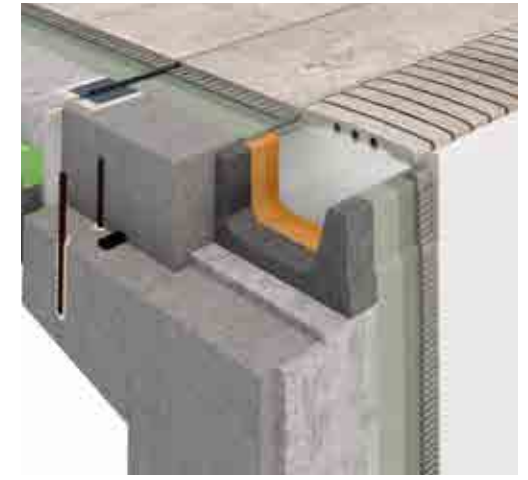

Wiesbaden

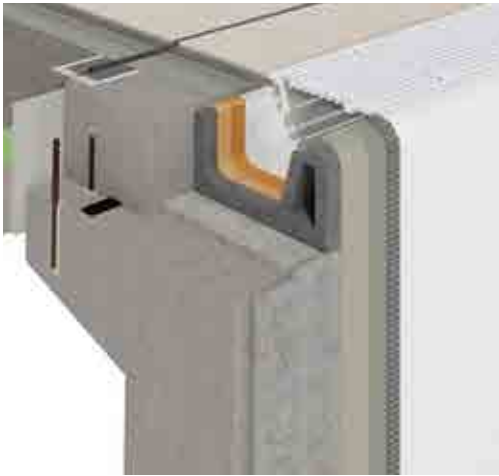

Spa

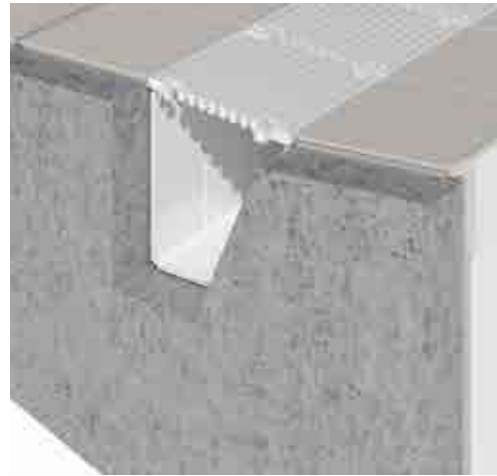

Zurich



Wiesbaden B

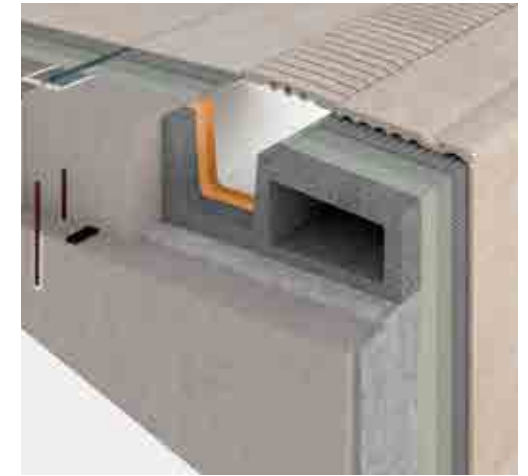

Prestige

Aqua

Sistema desbordante | Overflow Pools Systems | Système à débordement

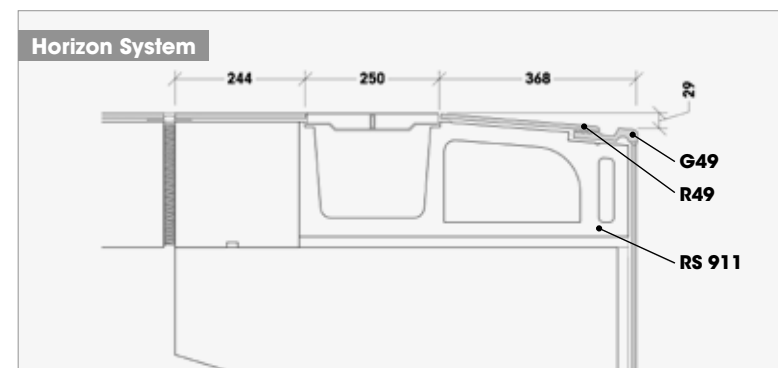
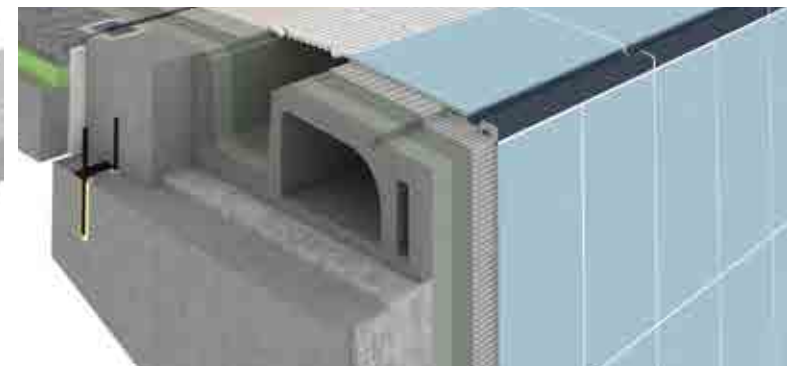
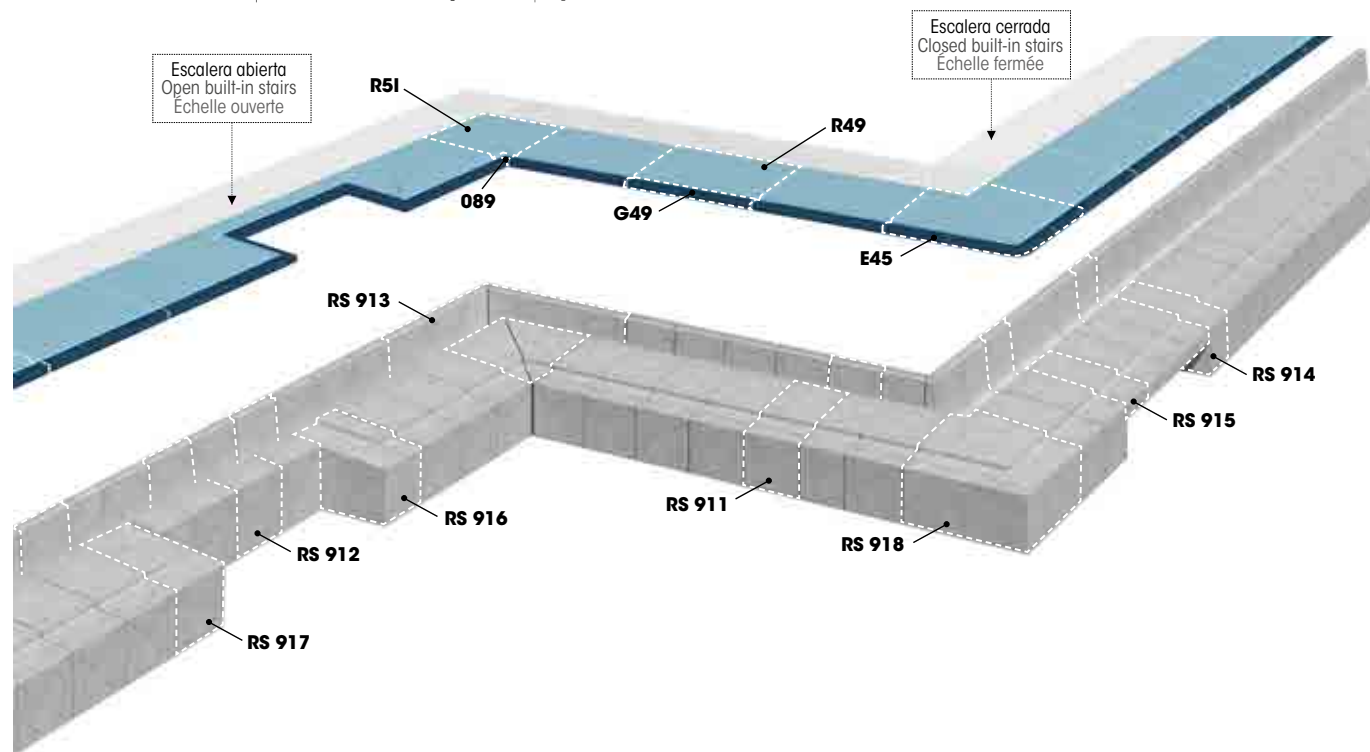

Bloques S9 | S9 Blocks | Modules S9

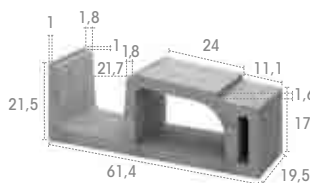

RS 911
Base
Base
Base

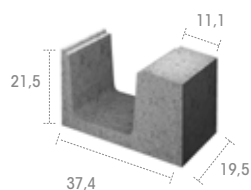

RS 912
Escalera abierta
Open built-in stairs
Échelle ouverte

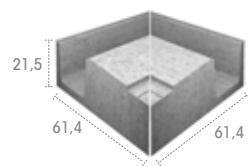

RS 913
Esquina Interior
Inside corner
Angle intérieur

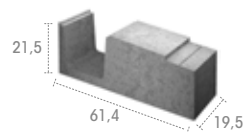

RS 914
Maciza
Solid
Solide

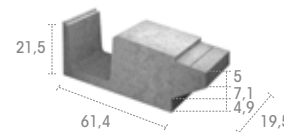

RS 915
Escalera cerrada
Closed built-in stairs
Échelle fermée

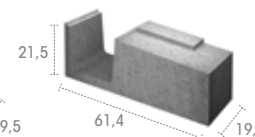

RS 916
Escalera abierta,
esquina derecha
Open built-in stairs,
right corner
Échelle ouverte,
coin droit

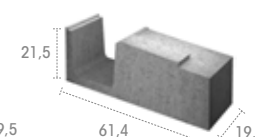

RS 917
Escalera abierta,
esquina izquierda
Open built-in stairs,
left corner
Échelle ouverte,
coin gauche

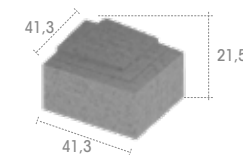

RS 918
Esquina exterior
Outside corner
Angle extérieur

Sistemas constructivos | Construction systems | Systèmes de construction

Dos piezas cerámicas de gran formato que conforman una suave pendiente y facilitan el agarre del bañista.

Comprising 2 large format ceramic tiles that form a gentle slope and provide bathers a better grip.

Deux pièces céramiques de grand format qui forment une pente douce et facilitent l'adhérence de l'utilisateur.

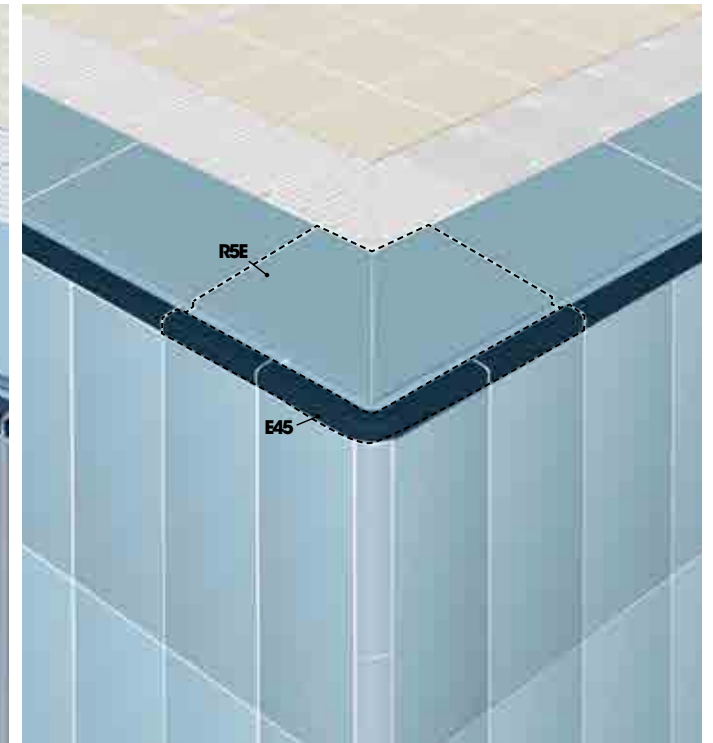
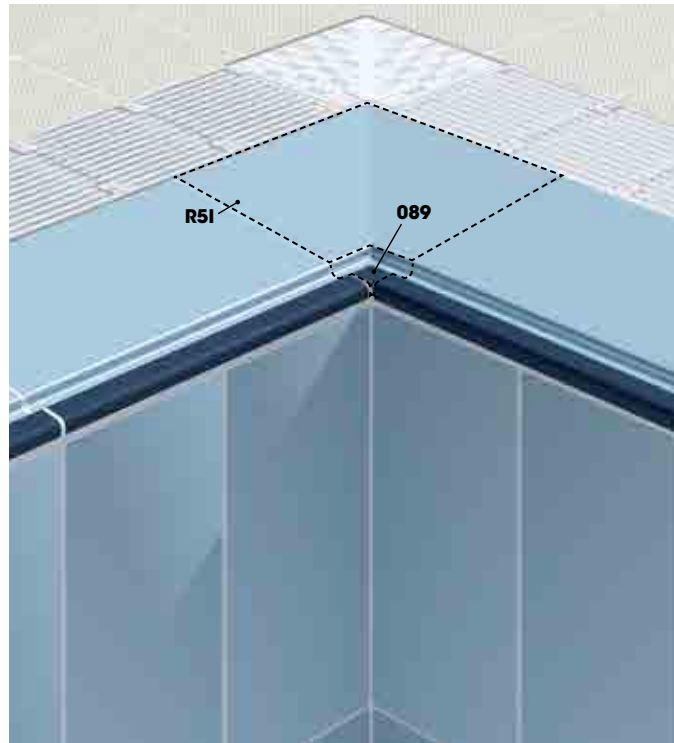
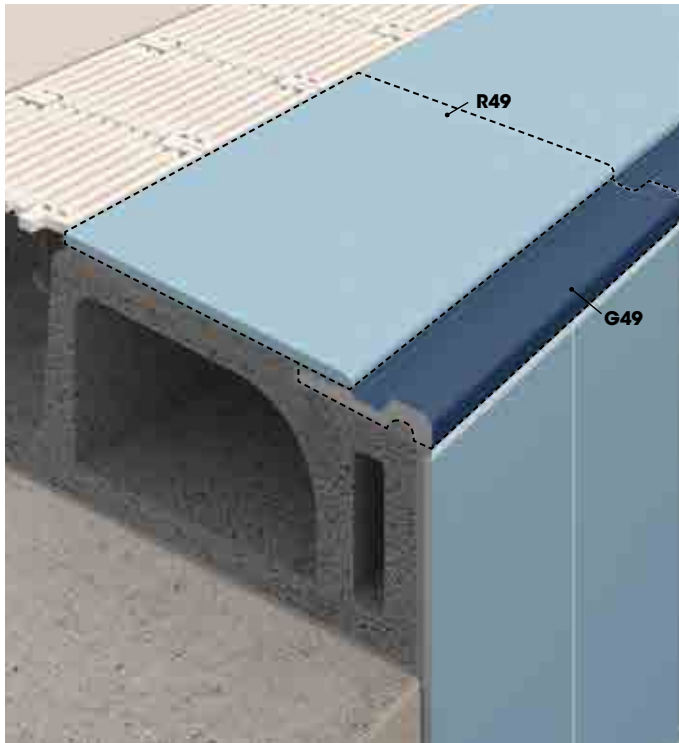

Piezas de borde y esquinas | Coping tiles and corners | Pièces de bord et angles

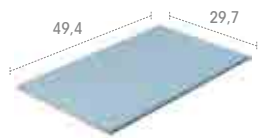

R49
anti-slip



G49
anti-slip

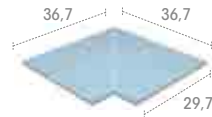

R51
anti-slip

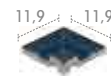

089
anti-slip

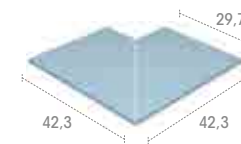

R5E
anti-slip



E45
anti-slip



Aqua

Sistema desbordante | Overflow Pools Systems | Système à débordement

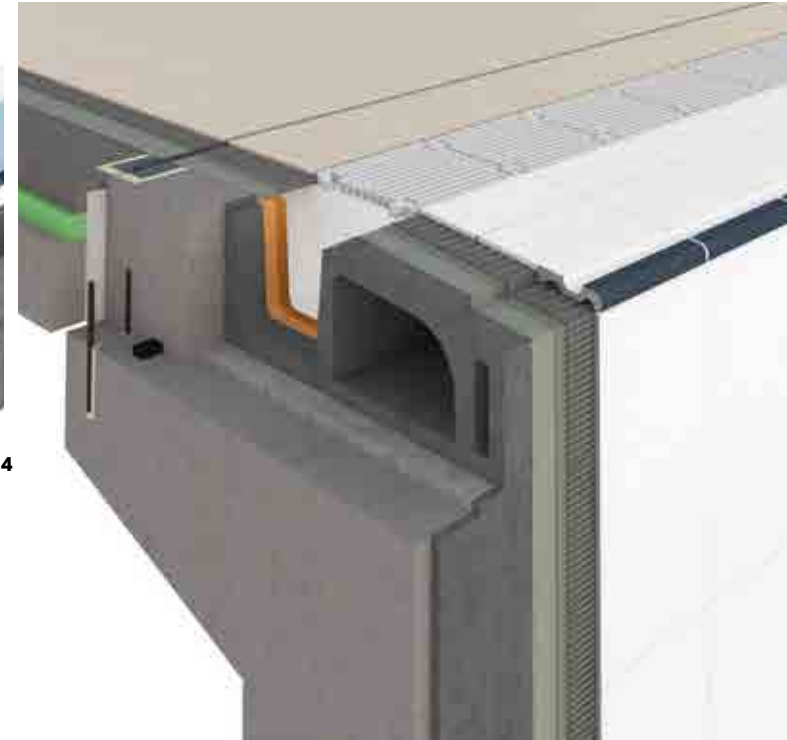
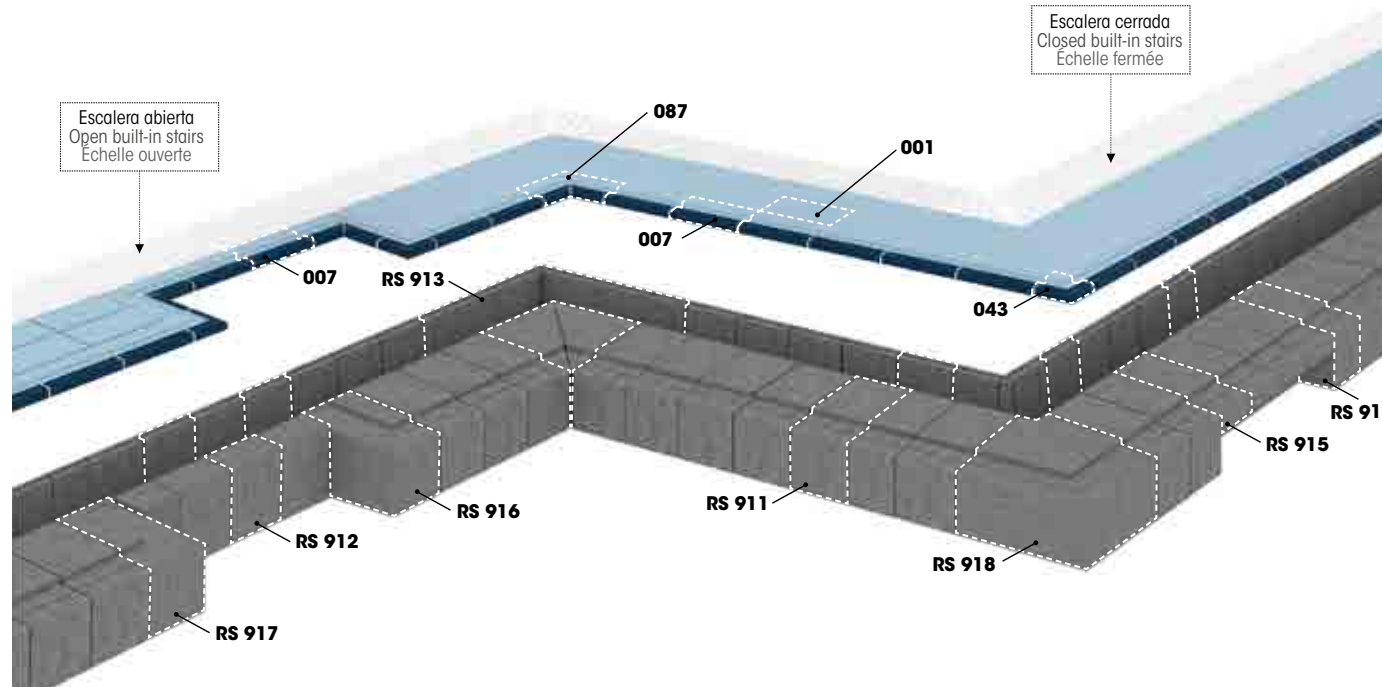

Bloques S9 | S9 Blocks | Modules S9

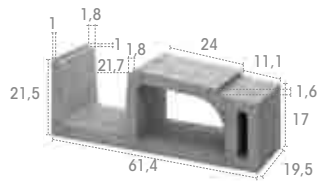

RS 911
Base
Base
Base

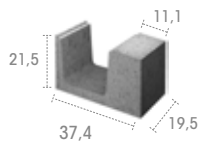

RS 912
Escalera abierta
Open built-in stairs
Échelle ouverte

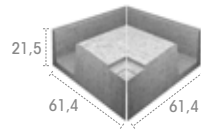

RS 913
Esquina Interior
Inside corner
Angle intérieure

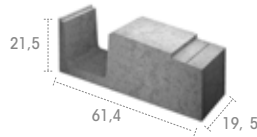

RS 914
Maciza
Solid
Solide

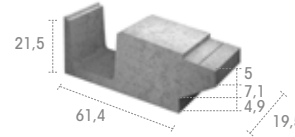

RS 915
Escalera cerrada
Closed built-in stairs
Échelle fermée

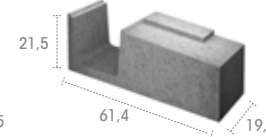

RS 916
Escalera abierta,
esquina derecha
Open built-in stairs,
right corner
Échelle ouverte,
coin droit

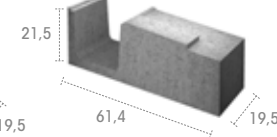

RS 917
Escalera abierta,
esquina izquierda
Open built-in stairs,
left corner
Échelle ouverte,
coin gauche

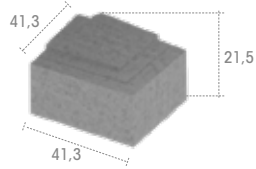

RS 918
Esquina exterior
Outside corner
Angle extérieure

Sistemas constructivos | Construction systems | Systèmes de construction

Sistema clásico de pre-playa descendente. Los bloques S9 proporcionan la pendiente necesaria y solucionan el apoyo de rejilla.

A classic downward-sloping pre-deck system. The S9 blocks provide the necessary slope and grate support.

Système classique d'avant-plage descendante. Les blocs S9 offrent la pente nécessaire et servent d'appui pour la grille.

Piezas de borde y esquinas | Coping files and corners | Pièces de bord et angles

Maciza | Solid | Solide

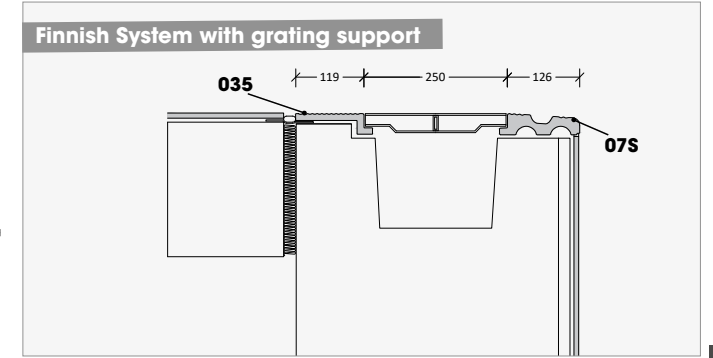
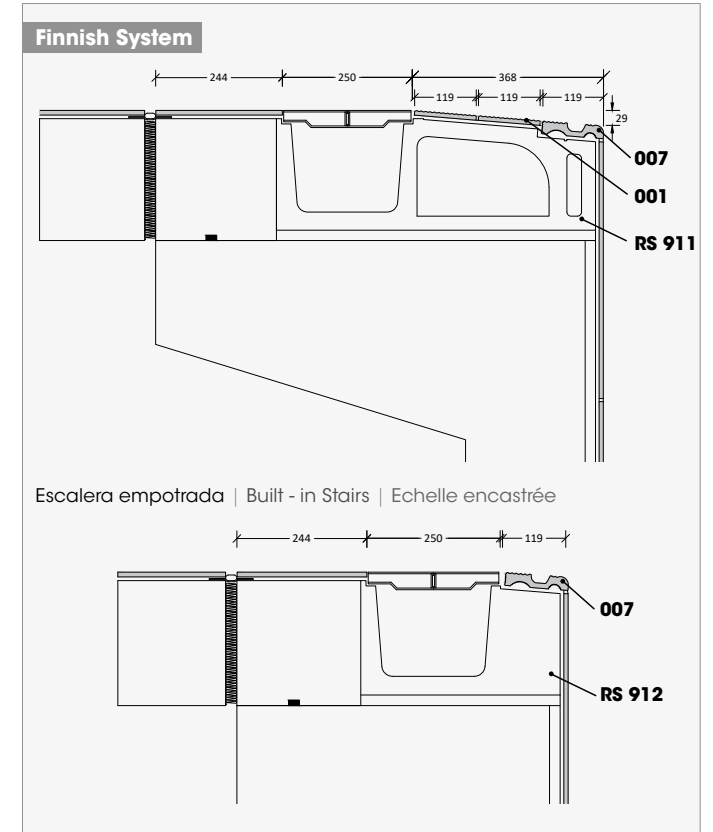
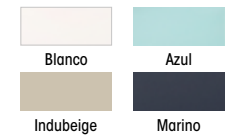
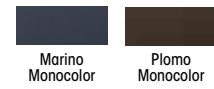
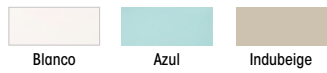
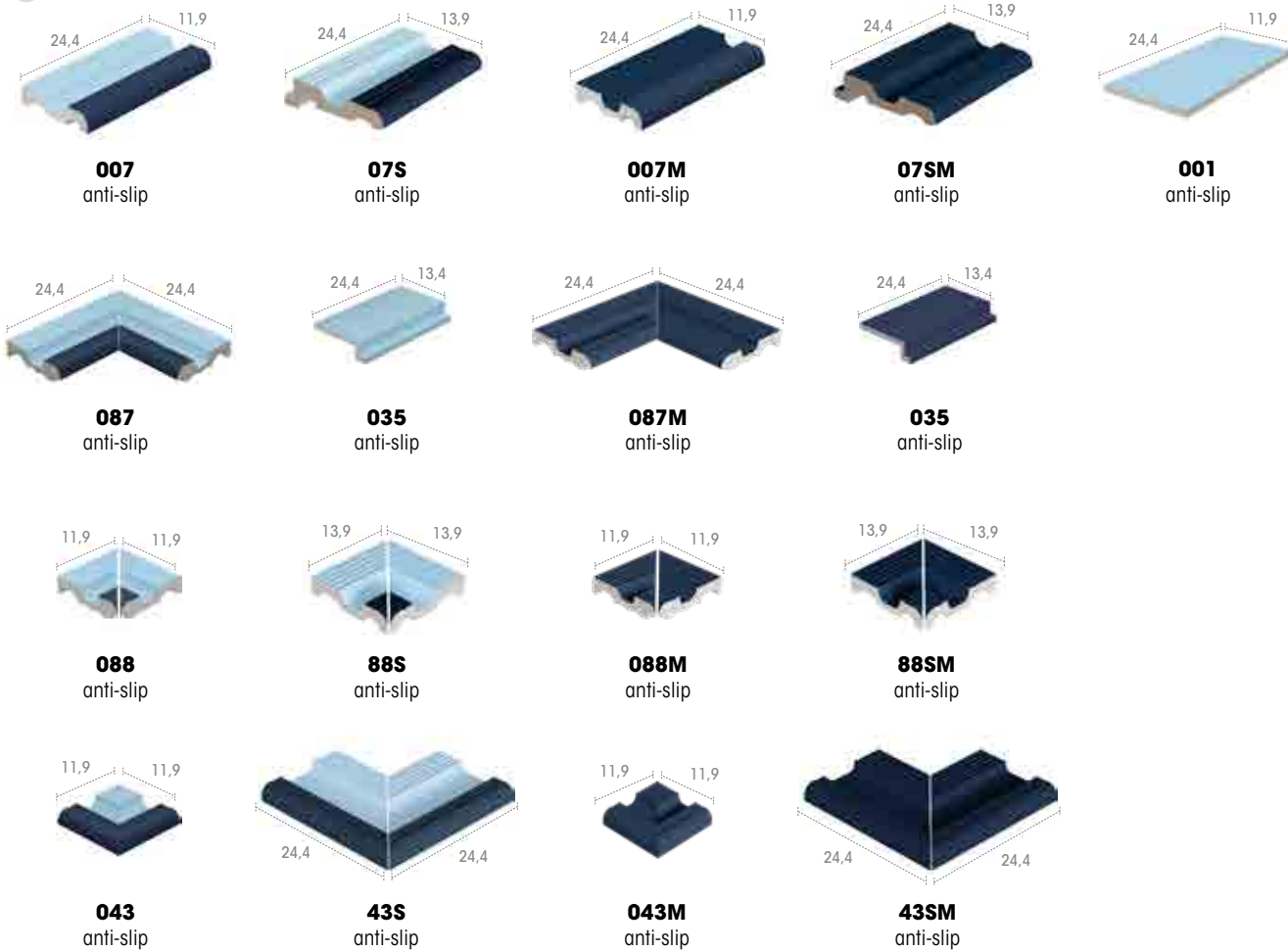

Aqua

Sistema desbordante | Overflow Pools Systems | Système à débordement

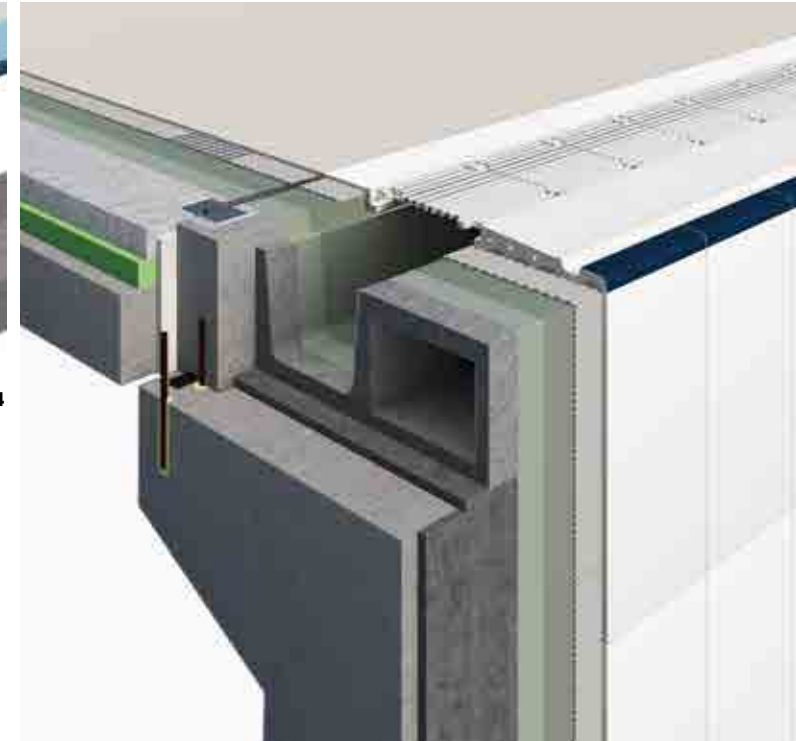
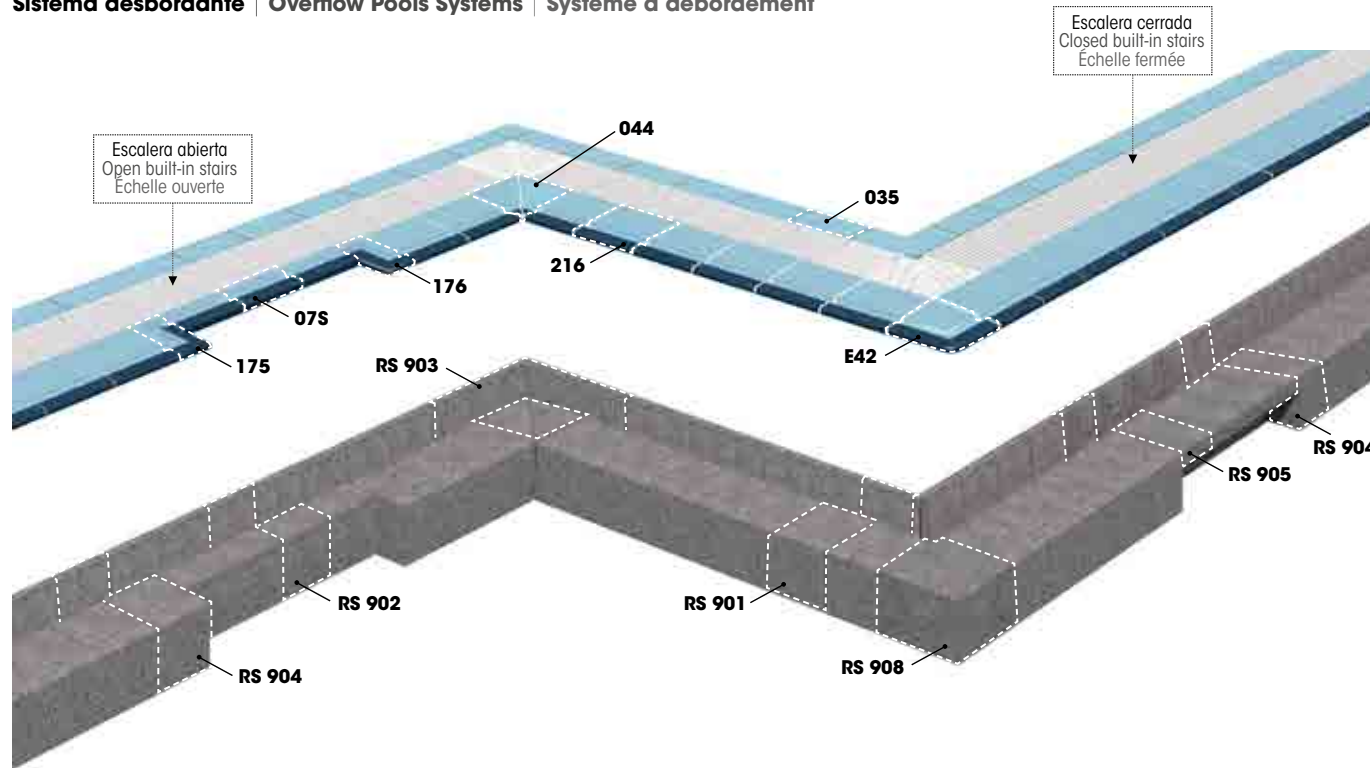

Bloques S9 | S9 Blocks | Modules S9

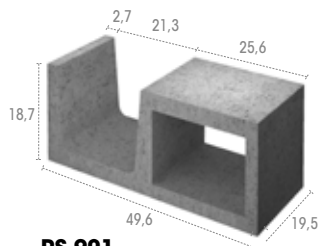

RS 901
Base
Base
Base

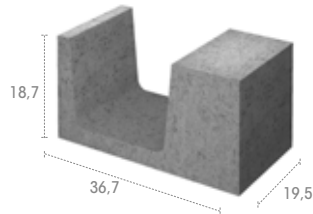

RS 902
Escalera abierta
Open built-in stairs
Echelle ouverte

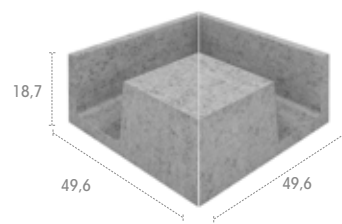

RS 903
Esquina Interior
Inside corner
Angle intérieur

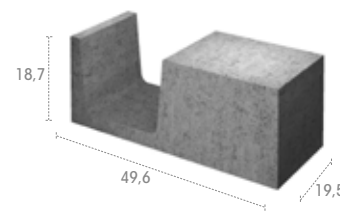

RS 904
Maciza
Solid
Solide

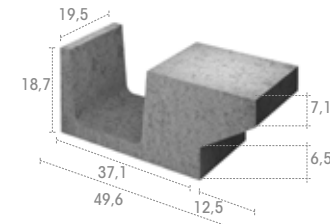

RS 905
Escalera cerrada
Closed built-in stairs
Echelle fermée

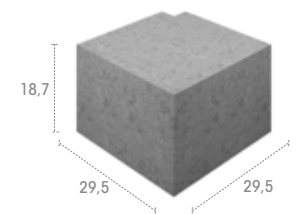

RS 908
Esquina exterior
Outside corner
Angle extérieur

Sistemas constructivos | Construction systems | Systèmes de construction

Sistema de pre-playa descendente solucionado con dos únicas piezas. La pieza de borde proporciona la pendiente de la pre-playa y actúa como soporte cerámico para la rejilla.

A downward-sloping pre-deck system with only two pieces. The edge piece provides the pre-deck slope and acts as a ceramic support for the grate.

Système d'avant-plage descendante constitué de 2 pièces. Le bord donne la pente de l'avant-plage et sert de support pour la grille. La pièce arrière côté plage sert aussi de support pour la grille.

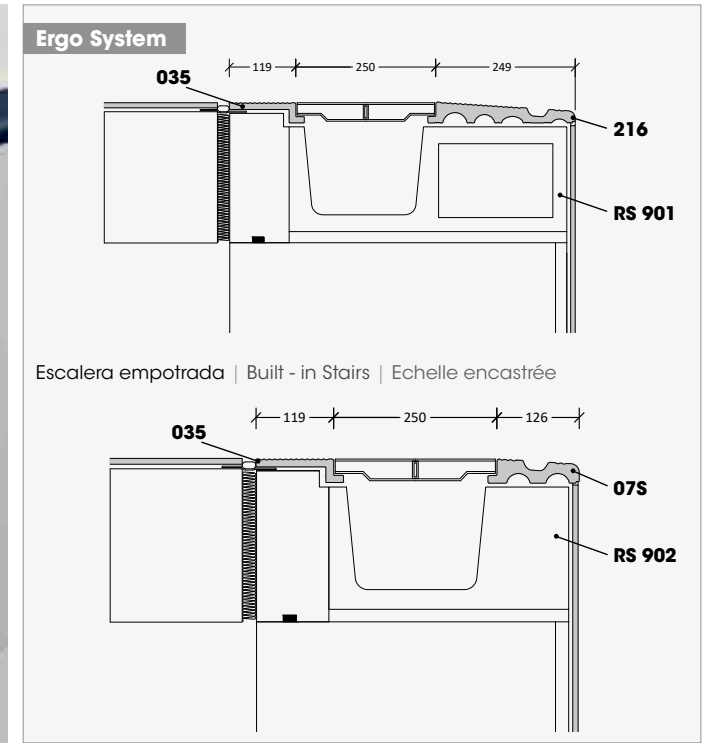
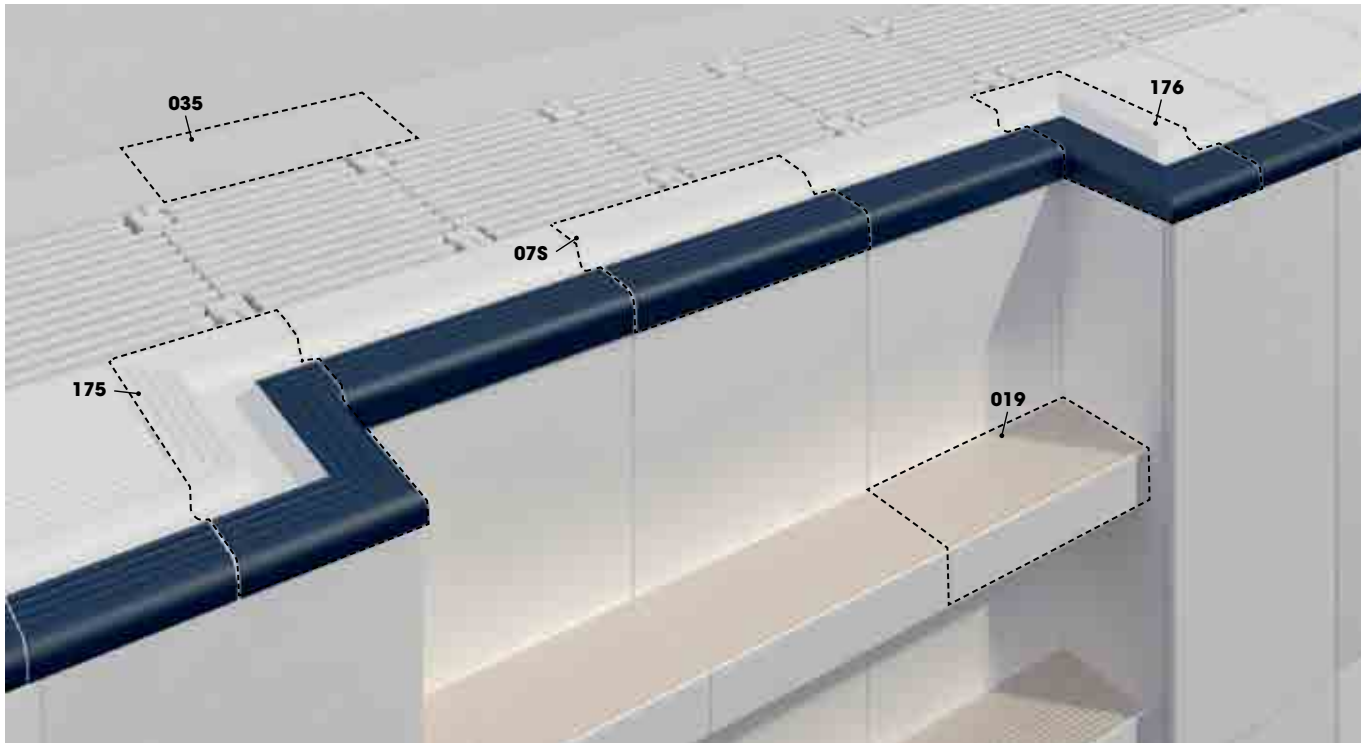

Piezas de borde y esquinas | Coping tiles and corners | Pièces de bord et angles



Maciza | Solid | Solide

216
anti-slip

044
anti-slip

E42
anti-slip

07S
anti-slip

175
anti-slip

176
anti-slip



Aqua

Sistema desbordante | Overflow Pools Systems | Système à débordement

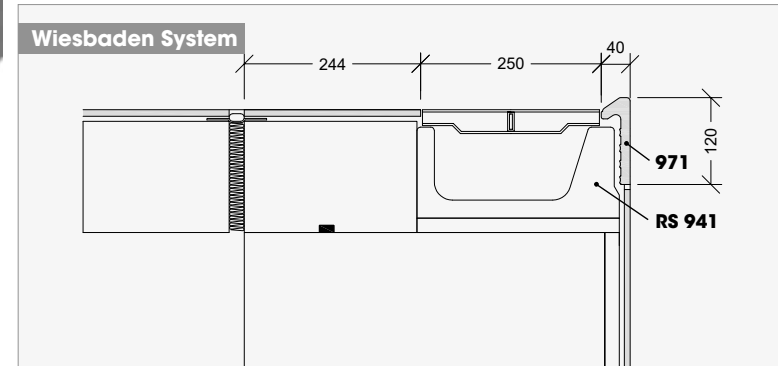
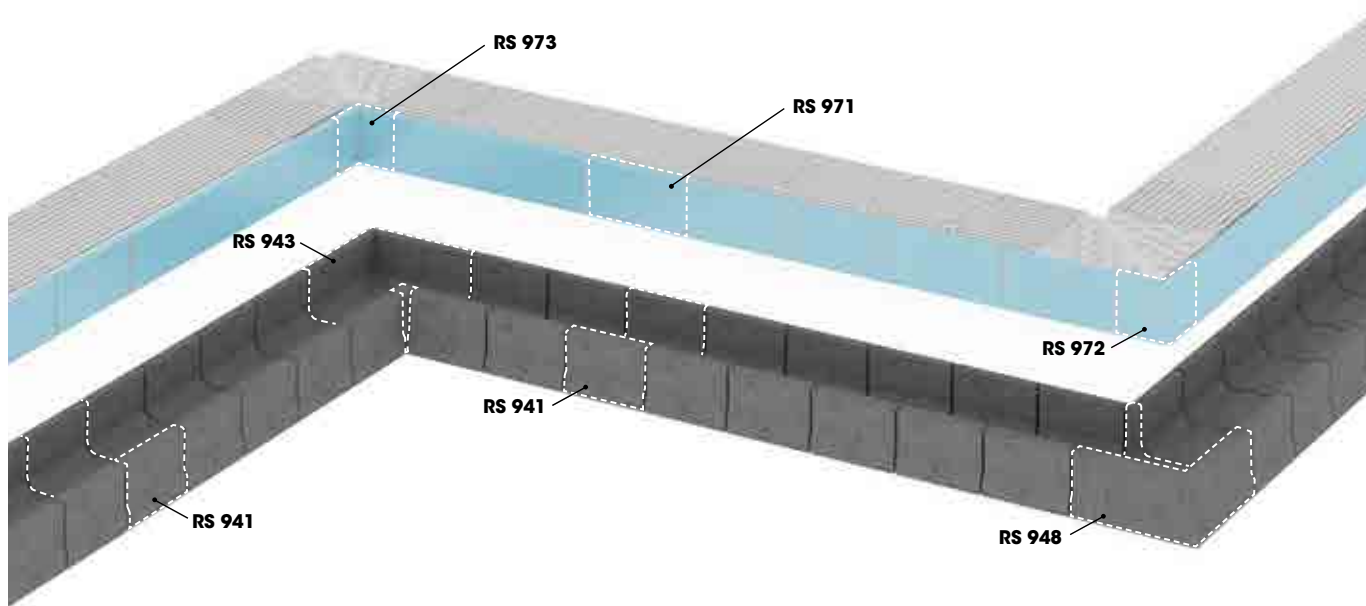

Bloques S9 | S9 Blocks | Modules S9

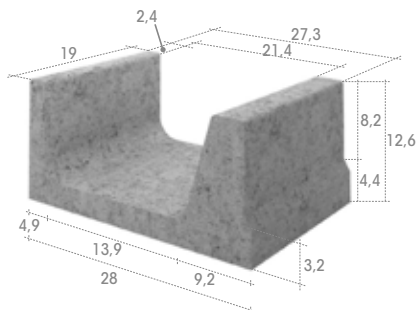

RS 941
Base
Base
Base

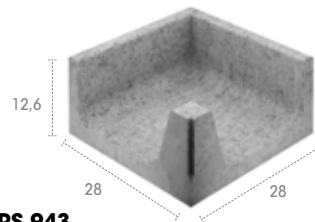

RS 943
Esquina Interior
Inside corner
Angle intérieur

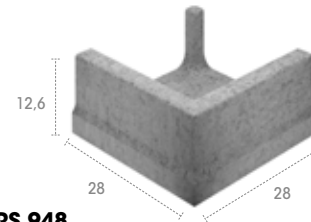

RS 948
Esquina exterior
Outside corner
Angle extérieur

Sistemas constructivos | Construction systems | Systèmes de construction

Ideal cuando se dispone de poco espacio de playa y se requiere: coste reducido, garantía de estanqueidad, gran capacidad de canal y facilidad de colocación.

This is ideal if you have a limited pool deck area and require a low price, guaranteed watertightness, a highcapacity channel, an easy installation and a wide range of colors.

Idéal lorsque l'on dispose de peu d'espace pour la plage. Parmi les nombreux avantages: coût réduit, garantie d'étanchéité, grande capacité de canal, pose facile et large gamme de couleurs.

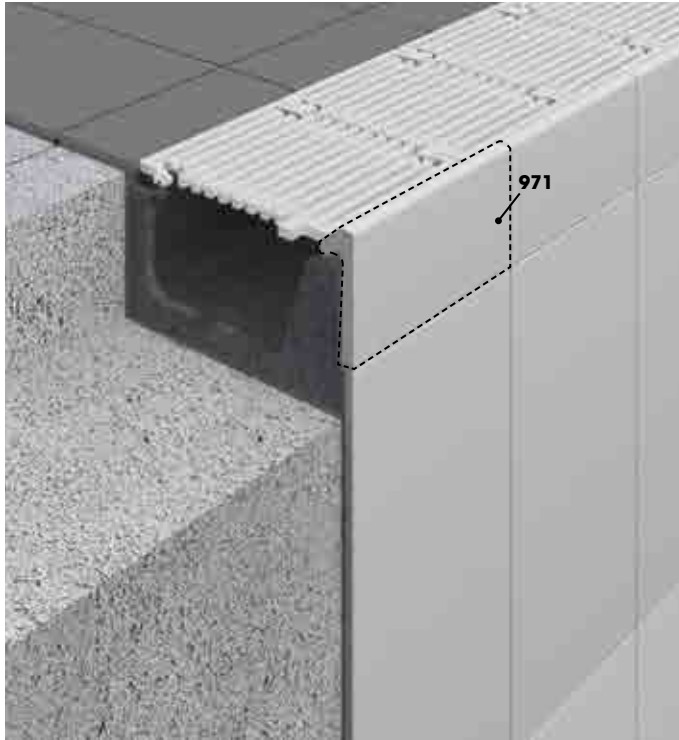

Aquaworld | Concorezzo, Italy | Architect: Federico Pella

Piezas de borde y esquinas | Coping tiles and corners | Pièces de bord et angles

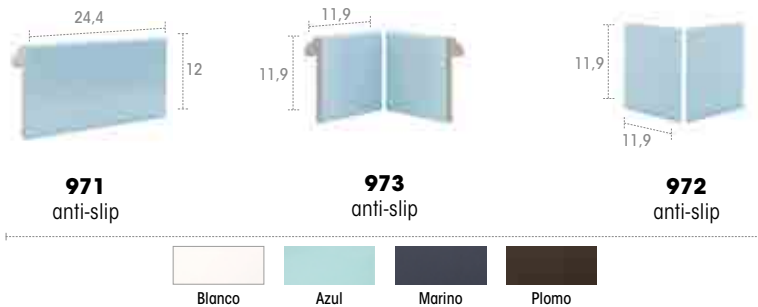

Aqua

Sistema desbordante | Overflow Pools Systems | Système à débordement

Creada para simplificar la construcción de piscinas desbordantes con mosaico, tanto públicas como residenciales. Sus principales ventajas son: facilidad de construcción, coste reducido, rapidez, poco espacio e infinidad de combinaciones de colores.

Created to simplify the construction of deck level pools with mosaic, both public and private. Its main advantages are ease of construction, low cost, speed, reduced space and the vast range of colour combinations.

Créé pour simplifier la construction des piscines à débordement avec mosaïque, aussi bien publiques que résidentielles. Ses principaux avantages sont: construction simplifiée, coût réduit, rapidité, espace réduit et une infinité de combinaisons de couleurs.

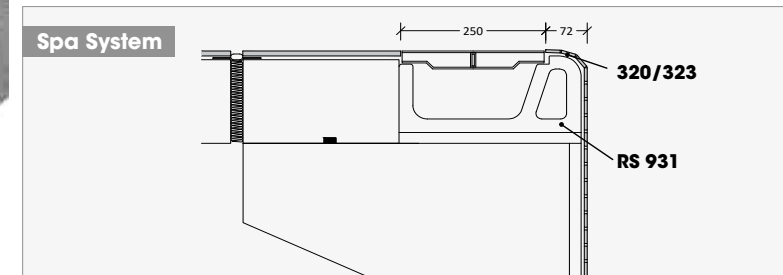
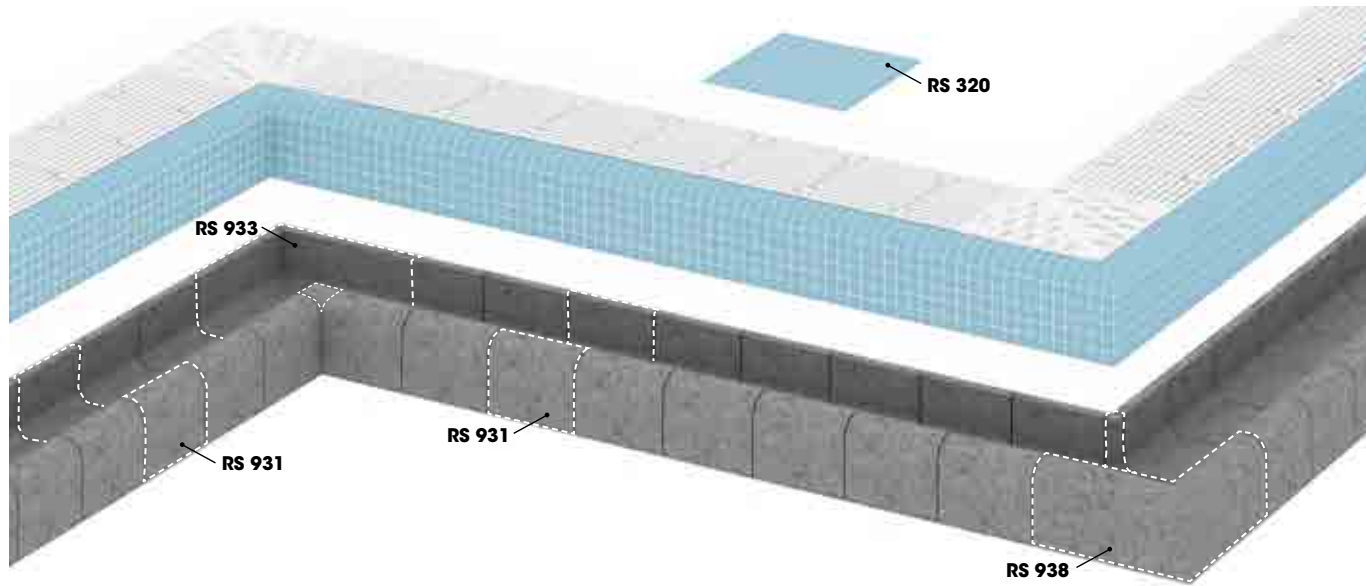

Bloques S9 | S9 Blocks | Modules S9

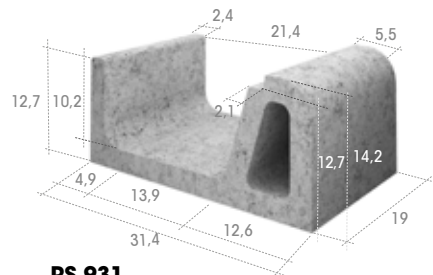

RS 931
Base
Base
Base

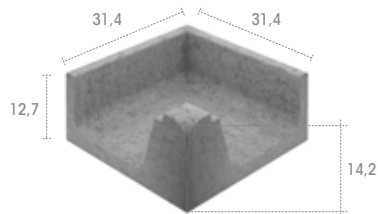

RS 933
Esquina Interior
Inside corner
Angle intérieur

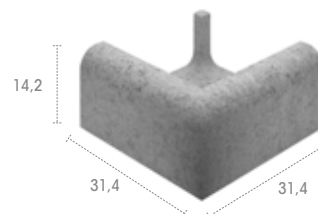

RS 938
Esquina exterior
Outside corner
Angle extérieur

Piezas de borde y esquinas | Coping tiles and corners | Pièces de bord et angles

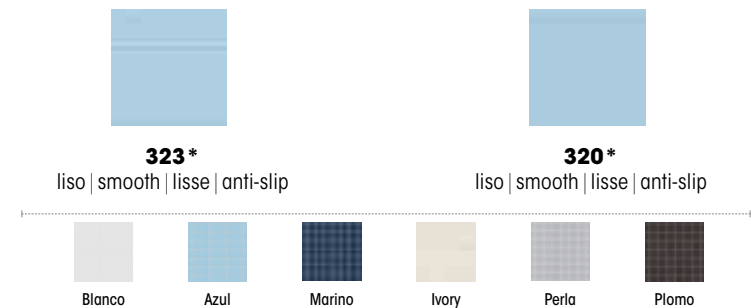

* Mosaico vítreo | Vitreous mosaic | Mosaïque vitrée

Zurich

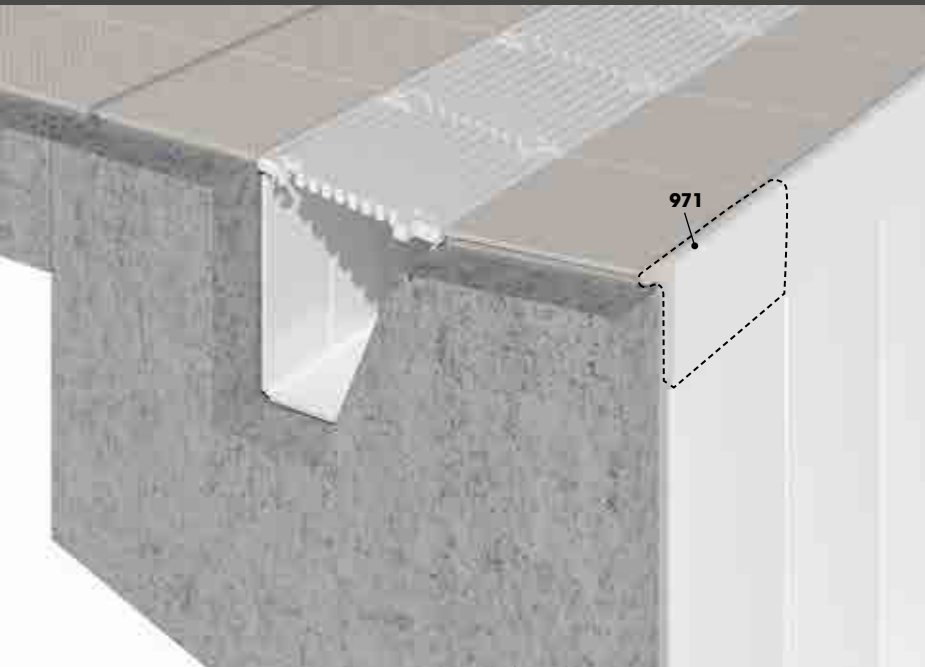

Zurich System

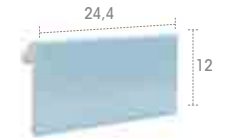
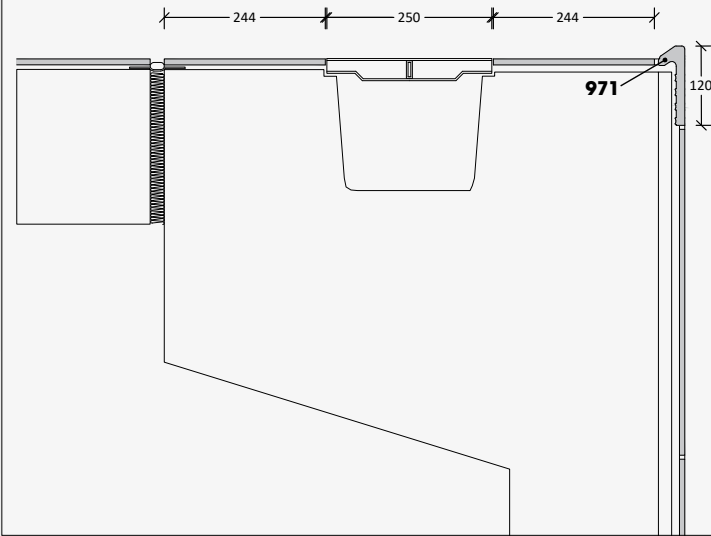

971 anti-slip



Wiesbaden B

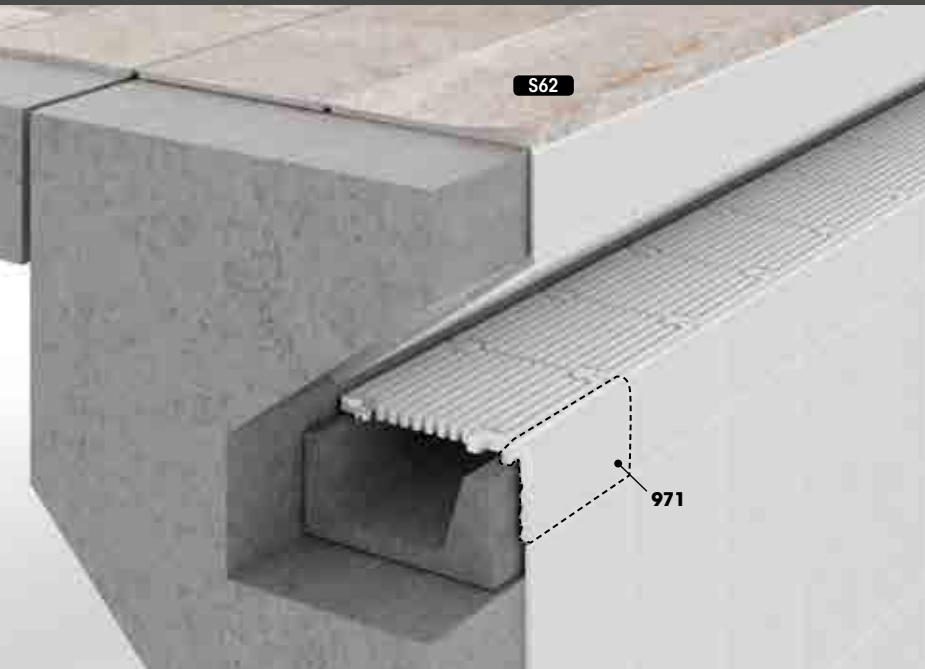

Wiesbaden B System

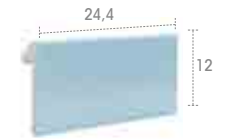
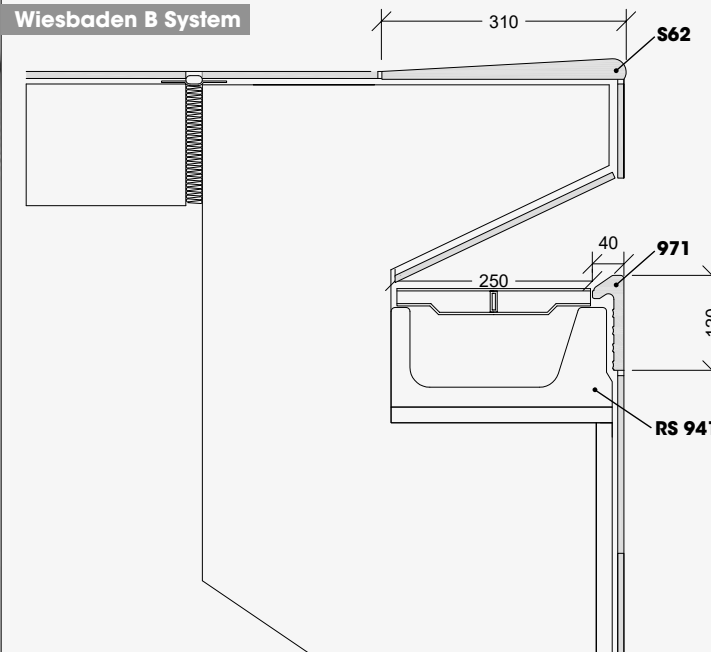

971 anti-slip



Mythos | Iconic | Trésor | Pietro | Serena | Mistery

Sistema desbordante | Overflow Pools Systems | Système à débordement

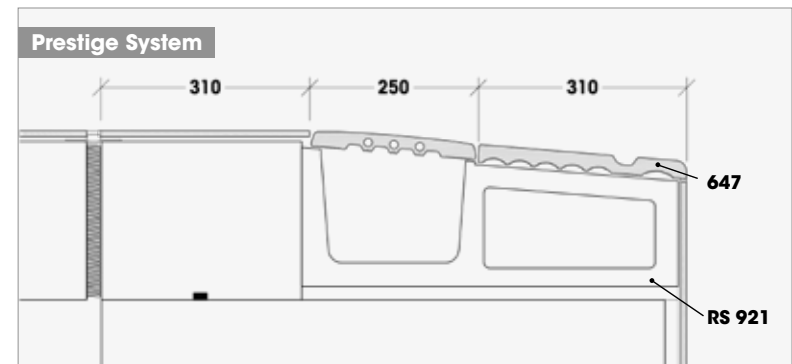
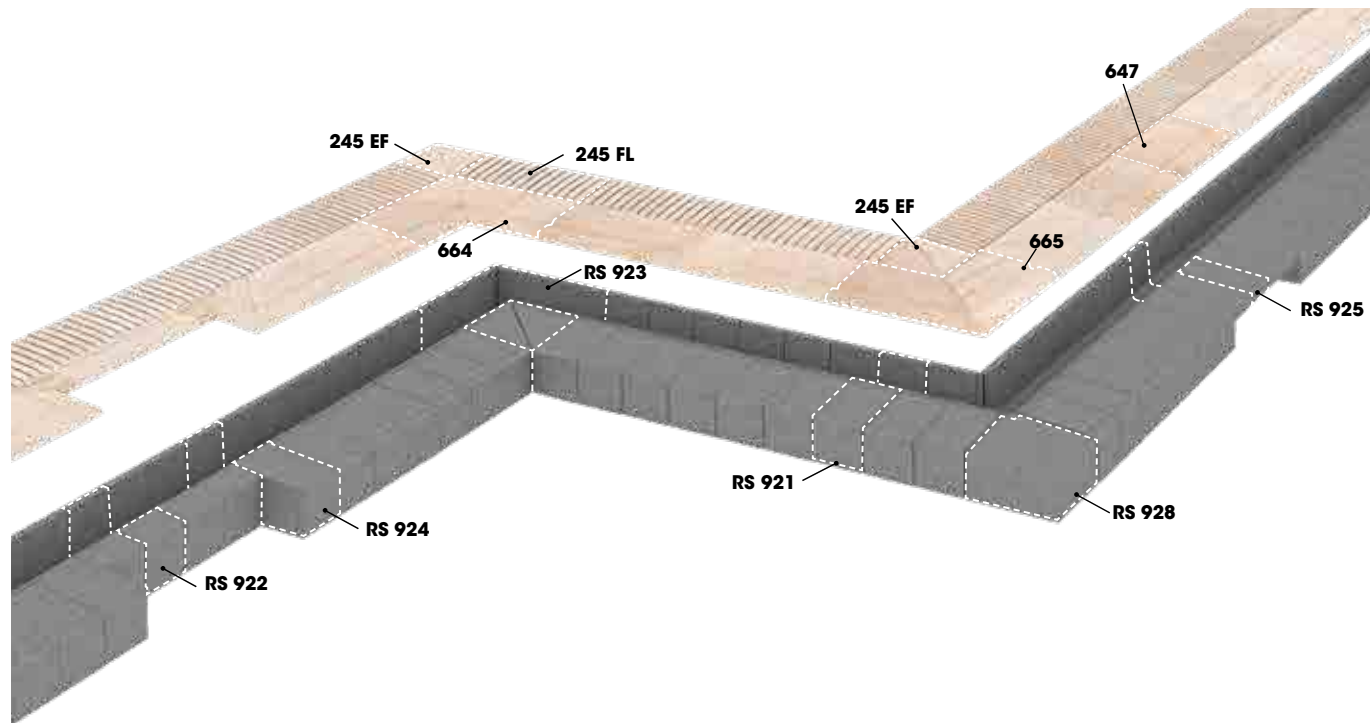

Bloques S9 | S9 Blocks | Modules S9

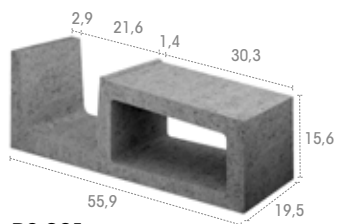

RS 921

Base

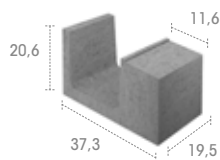

RS 922

Escalera abierta
Open built-in stairs
Échelle ouverte

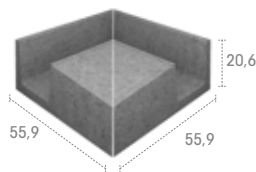

RS 923

Esquina interior
Inside corner
Angle intérieur

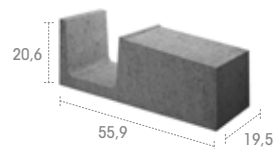

RS 924

Maciza
Solid
Solide

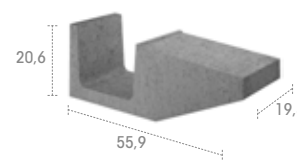

RS 925

Escalera cerrada
Closed built-in stairs
Échelle fermée

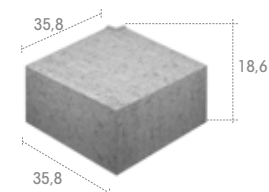

RS 928

Esquina exterior
Outside corner
Angle extérieur

Sistema de pre-playa descendente solucionado con la ref. 647 de 31 x 62,7 cm. Los bloques S9 generan la pendiente y funcionan como punto de apoyo para la rejilla del rebosadero.

Downward sloping pre-deck system using ref. 647 measuring 31 x 62.7 cm. S9 blocks provide the slope and support the overflow grate.

Système de débordement avant plage avec pente vers bassin avec la réf. 647 de 31 x 62,7 cm. Les blocs S9 génèrent la pente et servent de point d'appui à la grille de débordement.

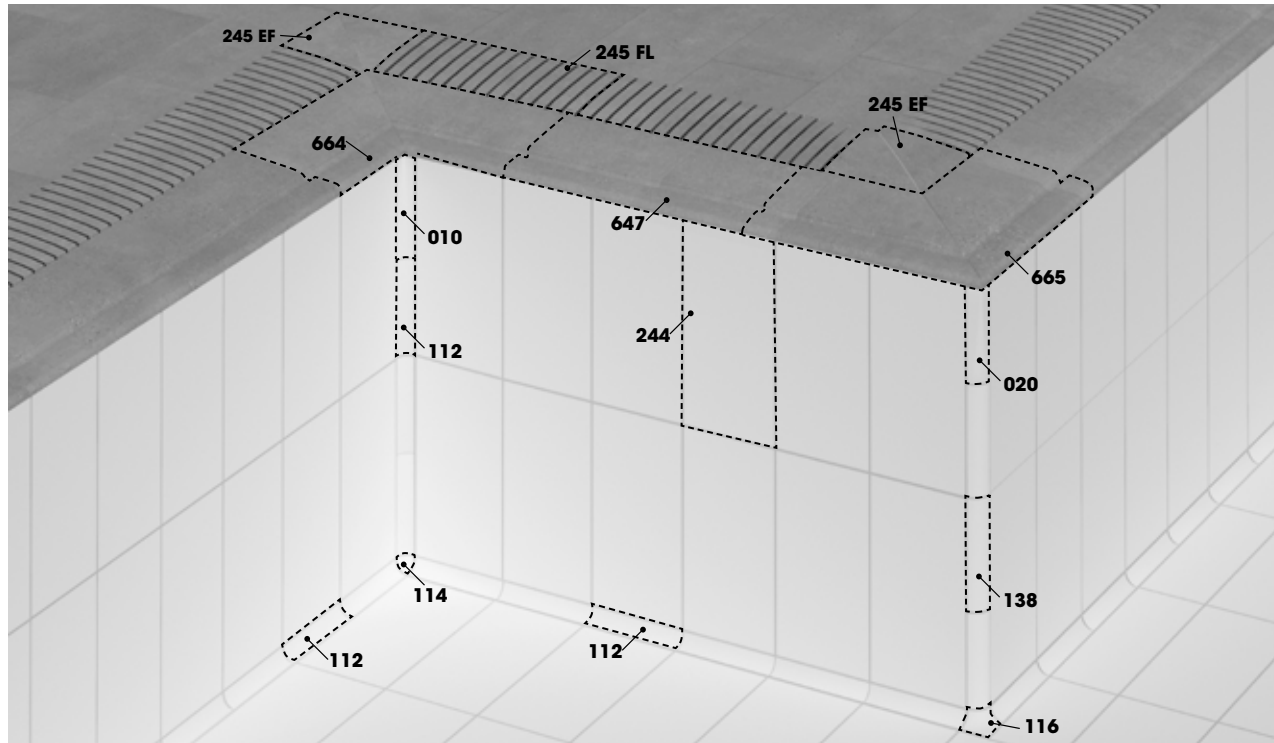

Para más información, viste la pág 114-115 de nuestro catálogo **Unique Pools Hotel & Spa.**

For more information, see pages 114-115 of our **Unique Pools Hotel & Spa** catalogue.

Pour plus d'informations, visitez les pages 114-115 de notre catalogue **Unique Pools Hôtel & Spa.**



Piezas de borde | Edge tiles | Margelles  Maciza | Solid | Solide

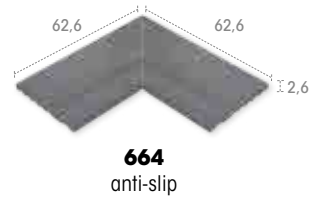
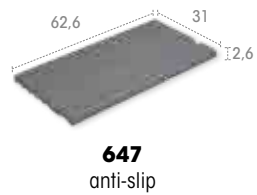

Mythos | Iconic | Trésor | Alma | Stela | Pietro | Serena | Mistery

Rejilla Flex | Flex Grid | Grille Flex

Su estructura en forma de trapecio evita el puente de agua incluso cuando está mal colocada. Facilita la reposición de piezas sueltas. Permite realizar curvas a partir de un radio de 75 cm.

Trapezoidal structure allows for perfect water flow even when poorly laid. Loose pieces can be easily repositioned. It can be used to create curves with a radius of more than 75 cm..

Sa structure trapézoïdale permet une parfaite évacuation de l'eau. La mise en place de pièces de remplacement est simplifiée. Permet de réaliser des courbes à partir d'un rayon de 75 cm.

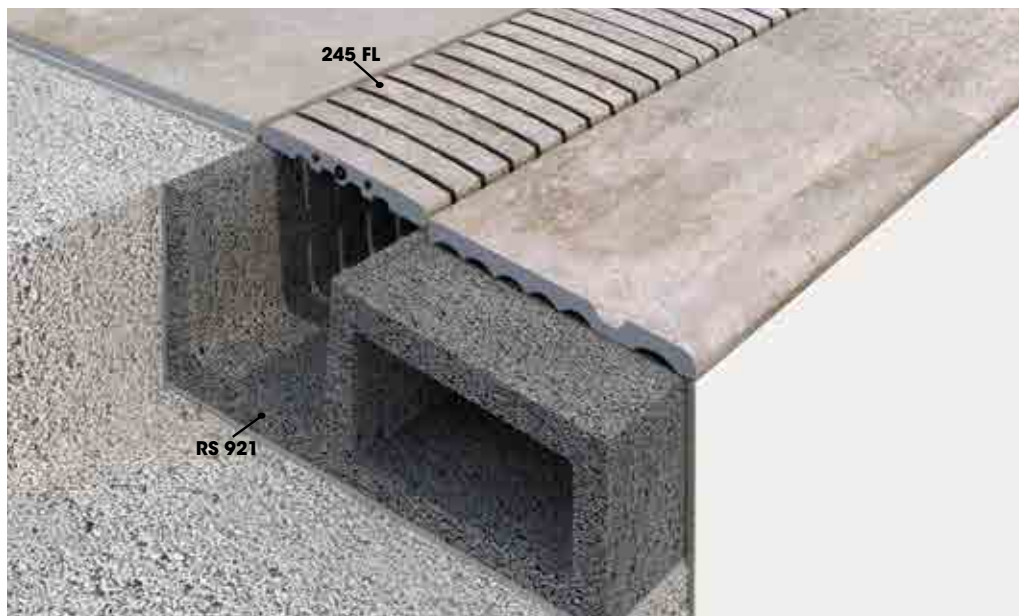

Piezas | Pieces | Pièces

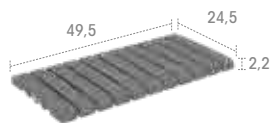

245 FL
anti-slip

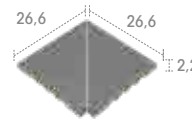

245 EF
anti-slip

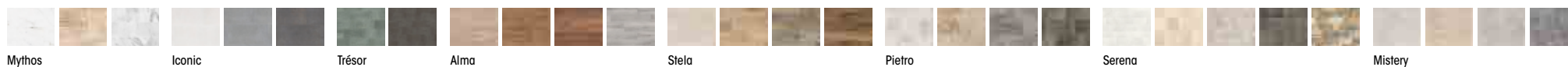

Mythos

Iconic

Trésor

Alma

Stela

Pietro

Serena

Mistery

Mythos | Iconic | Trésor | Alma | Stela | Pietro | Serena | Mistery

Rejilla Compact | Compact Grid | Grille Compact

Consiste en una sola pieza fabricada sin adhesivos. Al colocarla queda totalmente integrada con el borde. El desagüe se realiza a través de un sistema de orificios laterales apenas visible y con una capacidad óptima.

Composed of a single piece, without adhesives. Once in place, it blends in perfectly with the edge of the pool. The water is drained through side openings that are barely visible and have optimal capacity.

Elle consiste en une seule pièce, conçue sans adhésifs. Sa mise en place l'intègre totalement au débordement. Le drainage s'effectue à travers les mini canaux latéraux, à peine visibles mais d'une capacité optimale.

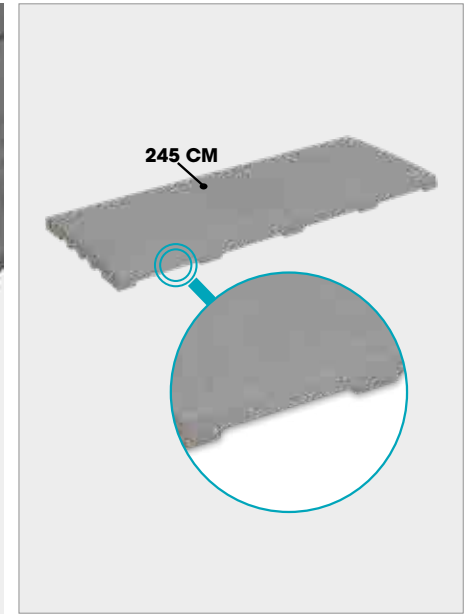

Piezas | Pieces | Pièces

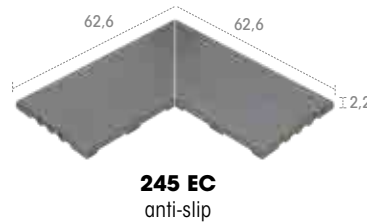
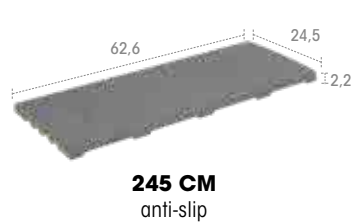

Se recomienda el uso de la rejilla compact en piscina pública, únicamente si se utiliza junto con el bloque RS921 del Sistema Prestige

The use of the compact grid in public pools is recommended only if used together with the Prestige System RS921 block.

Il est conseillé d'utiliser la grille compacte dans une piscine publique uniquement en combinaison avec le bloc RS921 du Système Prestige.

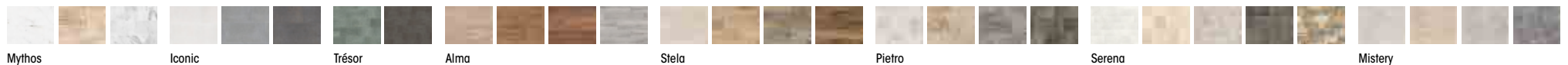

Aqua

Medias Cañas | Half-round pieces | Demi-Cannes

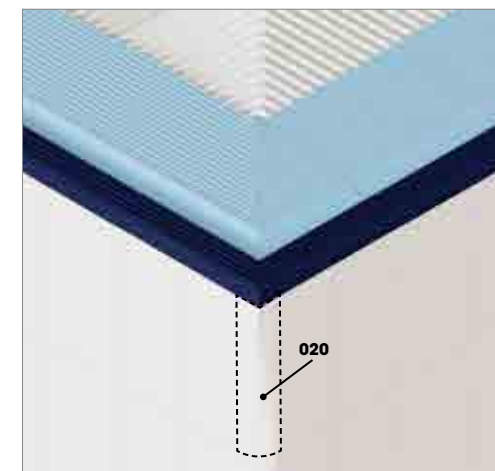
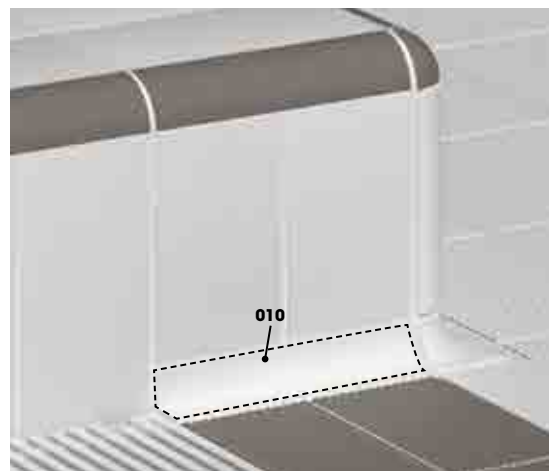
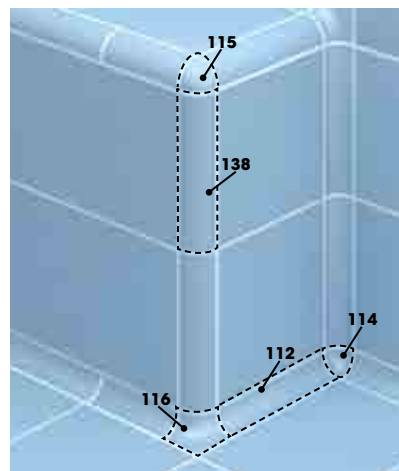
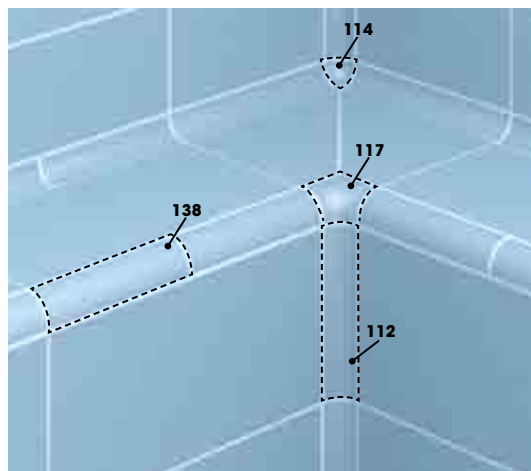

115

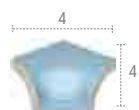

117

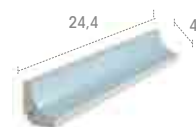

112

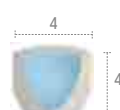

114



116



138



010

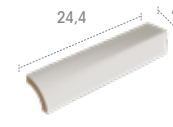

020

anti-slip

liso | smooth | lisse

liso | smooth | lisse

anti-slip

liso | smooth | lisse

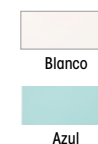

En estas dos referencias, **010** y **020**, uno de los extremos acaba en un ángulo recto de 90° mientras que el otro acaba en una curva con un radio de 4 cm.

These two references, **010** and **020**, have a curve with a 4-cm radius on one end and a 90° angle on the other end.

Ces deux références, **010** et **020**, se terminent à l'une des extrémités par un angle droit de 90°, et à l'autre extrémité par une courbure d'un rayon de 4 cm.

Aqua

Piezas estriadas | Grooved tiles | Pièces striées **Romo** | Bullnose | Arrondi

Números de profundidad | Depth files | Num. de profondeur

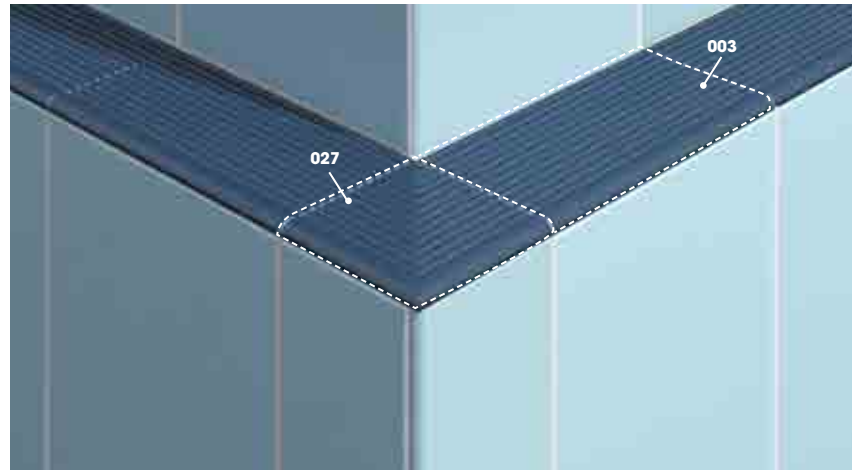
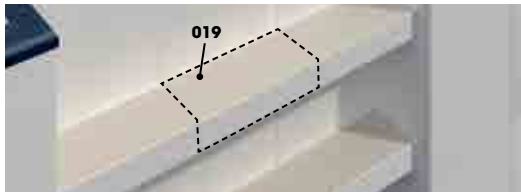

019	413	013	009	003	027	122 N9	122 PO/122 P8	C01 / C08	122 P9
anti-slip	liso smooth lisse	liso smooth lisse anti-slip	liso smooth lisse anti-slip	anti-slip	anti-slip	liso smooth lisse anti-slip	liso smooth lisse	liso smooth lisse	liso smooth lisse anti-slip
Blanco	Blanco, Azul	Blanco, Azul	Blanco, Azul	Blanco, Azul, Marino, Indubeige	Marino	Indubeige, Azul, Blanco	Blanco, Azul	Blanco, Azul	Blanco, Azul
	Azul, Marino, Plomo	Marino, Indubeige							
		Plomo							

Aqua

Cama de agua y escalera | Water bed and stairs | Banquette et escalier

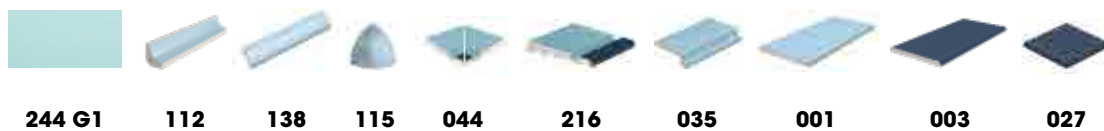
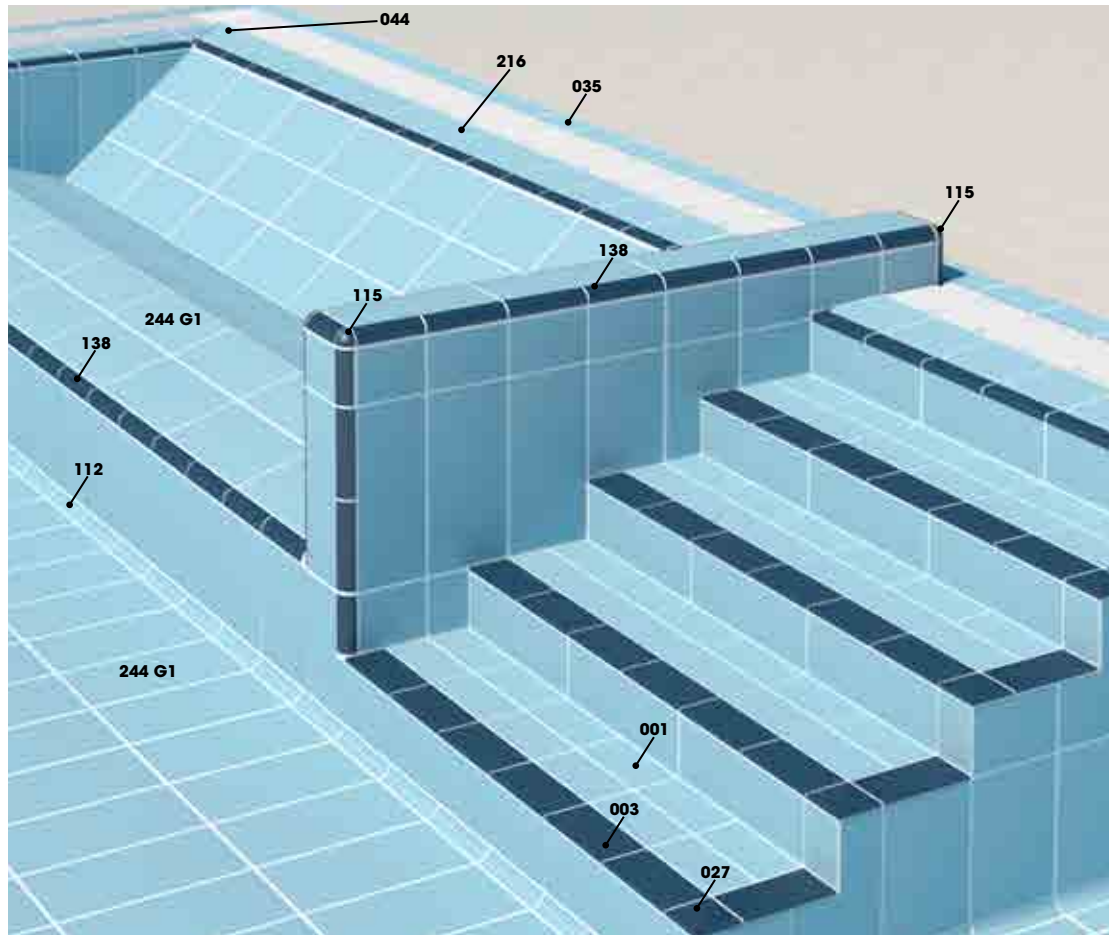

Murete y escalera cerrada | Headwall for podiums and closed stairs | Muret et échelle fermée

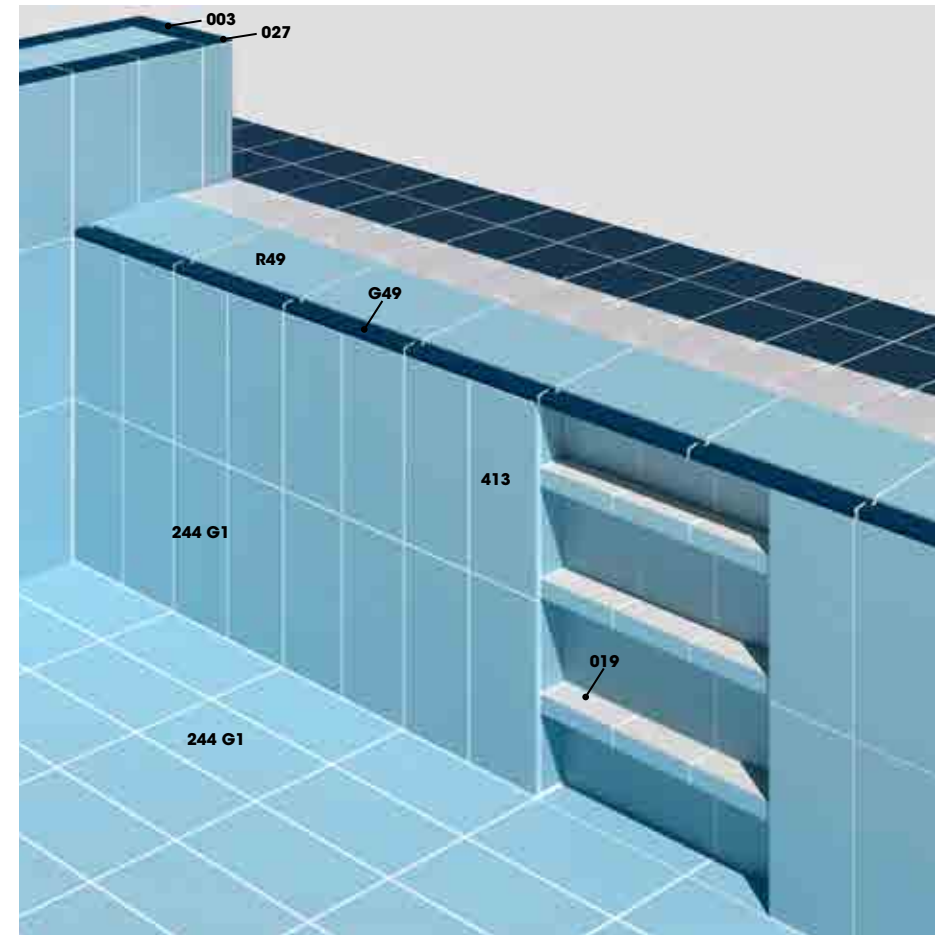

Aqua

Murete | Headwall for podiums | Muret

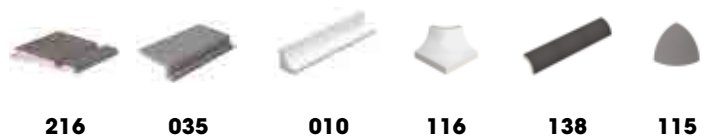
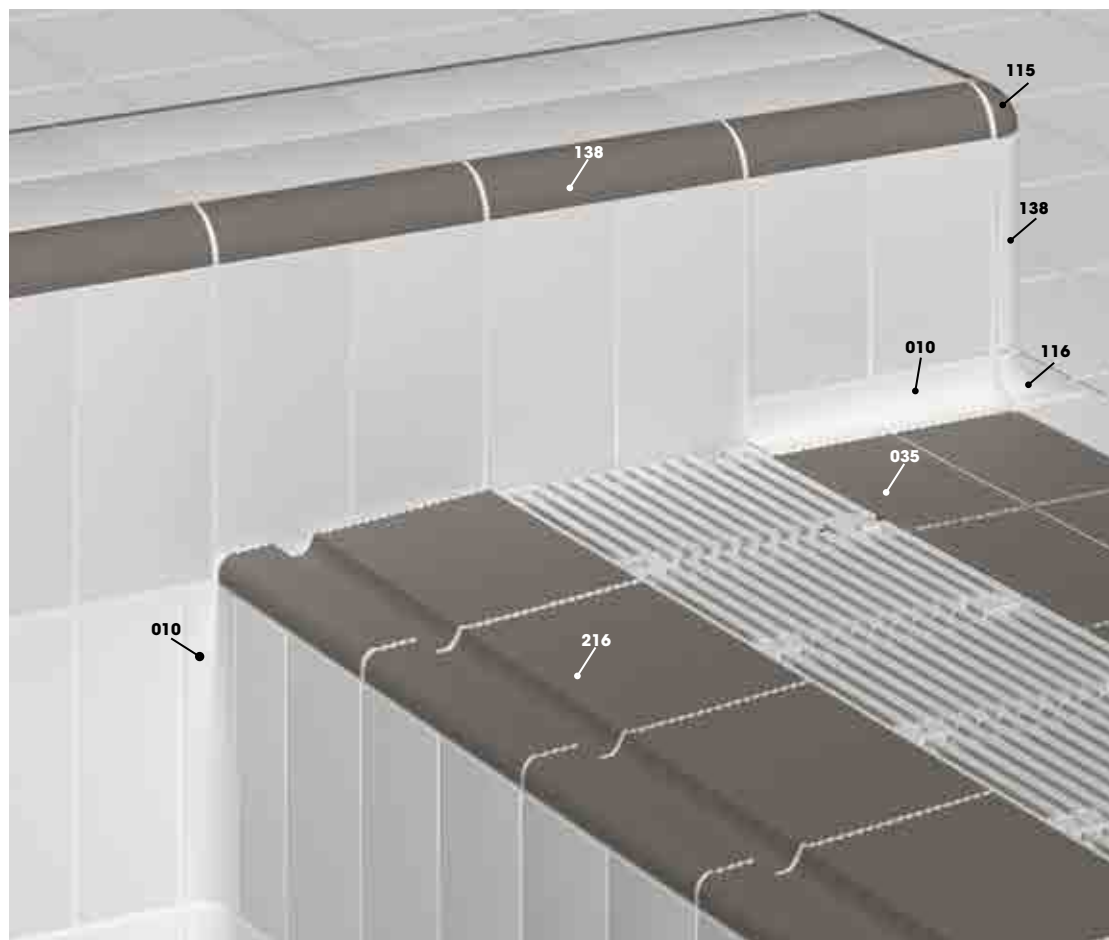

Banco | Bench | Banc

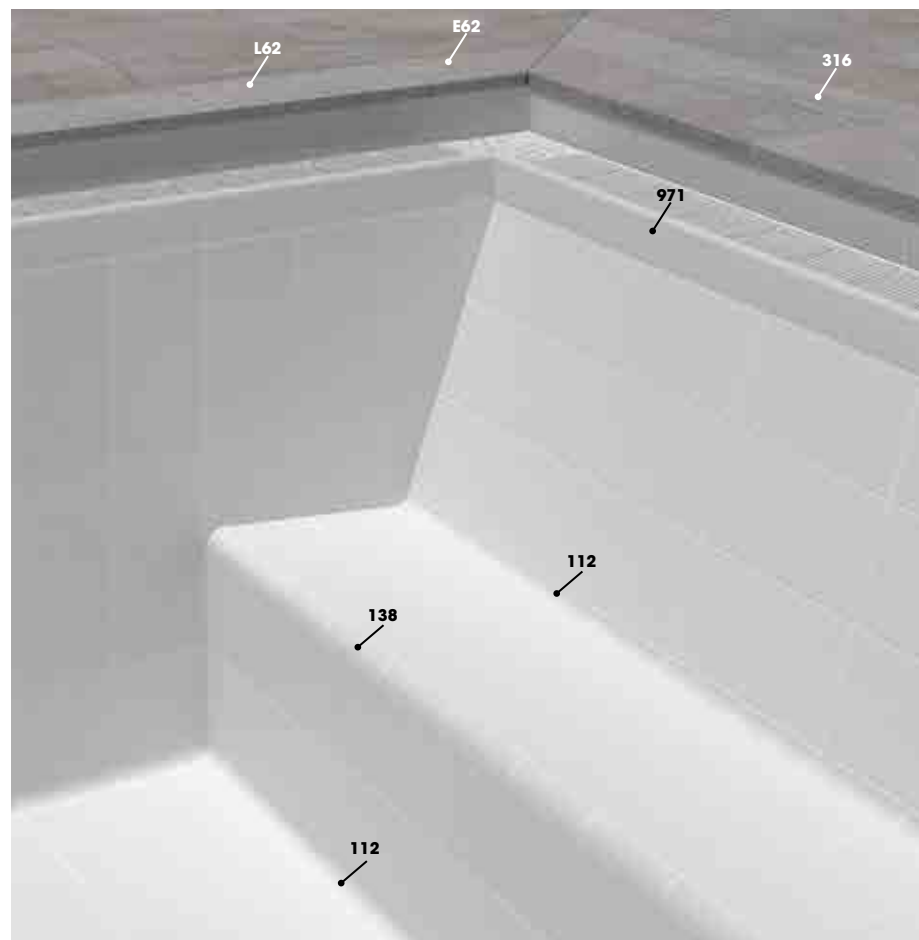

Aqua

Canaletas | Waterways | Cunettes

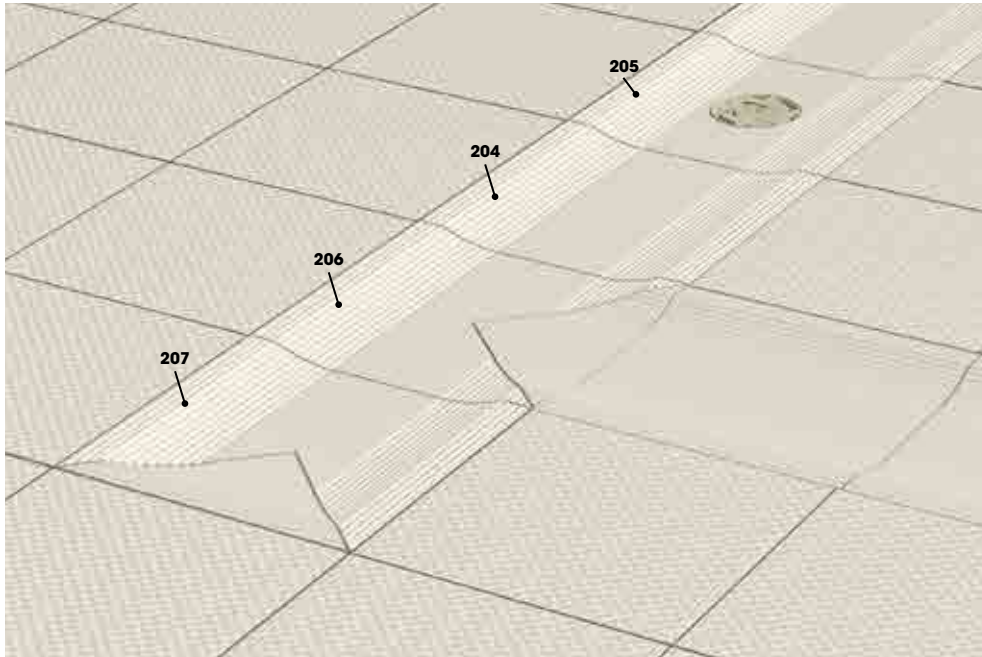

204
anti-slip

205
anti-slip

206
anti-slip

207
anti-slip



Indugres

Medias Cañas | Half-round pieces | Demi-cannes

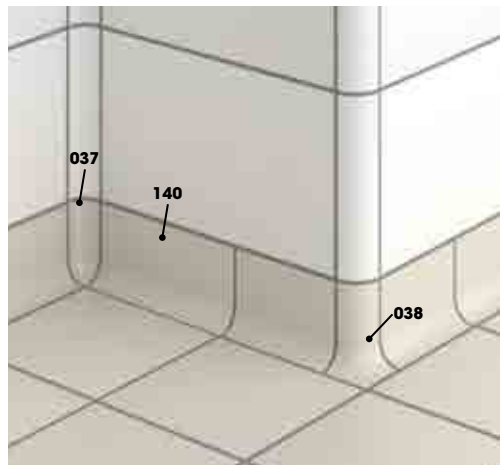

Canaletas | Waterways | Cunnete

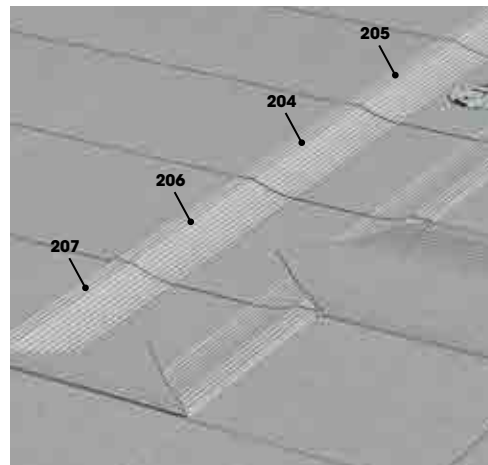

Plato de ducha | Shower Tray | Receveur de douche

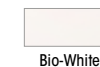
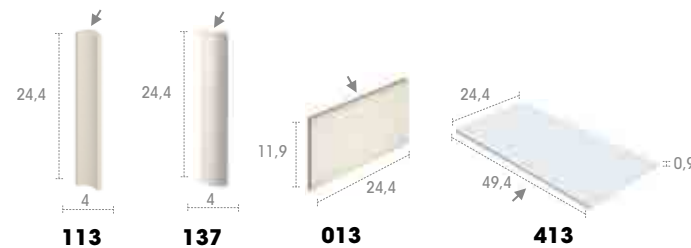
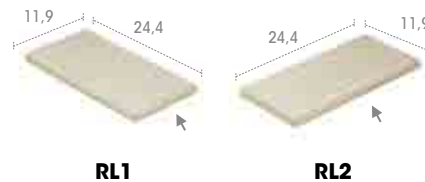
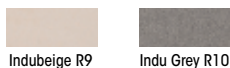
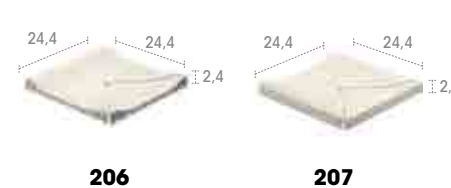
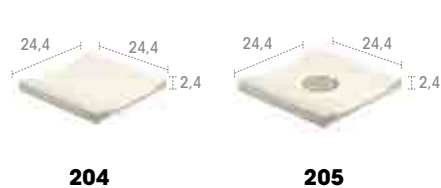
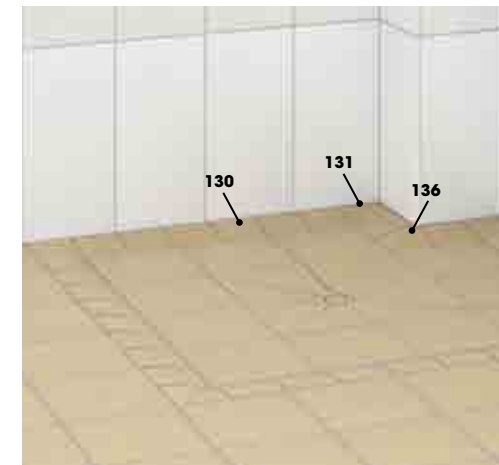

Romo | Bullnose | Arrondi

Complementos | Accessories | Accessoires

Rejillas | Grates | Grille

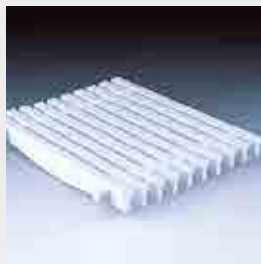

REJILLA GRATING GRILLE

Blanco

- 245 R2** 24,5 x 19,5 x 2,2
- 295 R2** 29,5 x 19,5 x 2,2
- 335 R2** 33,5 x 19,5 x 2,2



PLACA ESQUINA 90° 90° CORNER PLASTIC PIECE ANGLE POUR CAILLEBOTIS 90°

Blanco

- 195 E2** 19,5 x 19,5 x 2,2
- 245 E2** 24,5 x 24,5 x 2,2
- 295 E2** 29,5 x 29,5 x 2,2
- 335 E2** 33,5 x 33,5 x 2,2
- 195 E3** 20 x 20 x 3,5
- 245 E3** 25 x 25 x 3,5
- 295 E3** 30 x 30 x 3,5
- 335 E3** 34 x 34 x 3,5



REJILLA LONGITUDINAL LONGITUDINAL GRATE GRILLE PARALLÈLE

Blanco

- 195 L2** 19,5 x 20,6 x 2,4
- 245 L2** 24,5 x 20,6 x 2,4
- 295 L2** 29,5 x 20,6 x 2,4
- 345 L2** 34,5 x 20,6 x 2,4



PERFIL SOPORTE MIL (*) GRATING SUPPORT PROFILE (*) PROFIL SUPORT GRILLE (*)

Blanco

- 243 PF** 2,4 x 3,7 x 200

Se necesitan 2 unidades para sujetar la rejilla. Se venden por piezas de 2 m
2 units required to hold the grid. Sold in units of 2 m
Il faut 2 unités pour supporter la grille. Vente par pièces de 2 m



CURVASY RECTAS MODULAR GRATE FOR BENDS GRILLE POUR COURBES

Blanco

- 195 V2** 19,5 x 2,2
- 245 V2** 24,5 x 2,2
- 295 V2** 29,5 x 2,2
- 335 V2** 33,5 x 2,2
- 195 V3** 19,5 x 3,5
- 245 V3** 24,5 x 3,5
- 295 V3** 29,5 x 3,5
- 335 V3** 33,5 x 3,5



TERMINAL LONGITUDINAL END PIECE FOR LONGITUDINAL GRATING

Blanco

- 195 TO** 19,5 x 2,4
- 245 TO** 24,5 x 2,4
- 295 TO** 29,5 x 2,4
- 345 TO** 34,5 x 2,4



REJILLA LONGITUDINAL LONGITUDINAL GRATE GRILLE PARALLÈLE

Plomo

- 245 L2** 24,5 x 100 x 2,4



CURVASY RECTAS MODULAR GRATE FOR BENDS GRILLE POUR COURBES

Plomo

- 245 V2** 2,5 x 250 x 2,4



REJILLA (*) GRATING (*) GRILLE (*)

Plomo

- 245 R2** 24,5 x 250 x 2,4

Se venden por piezas de 2'5 m
Sold in units of 2'5 m
Vente par pièces de 2'5 m



PLACA ESQUINA 90° 90° CORNER PLASTIC PIECE ANGLE POUR CAILLEBOTIS 90°

Plomo

- 245 E2** 24,5 x 24,5 x 2,4

Corcheras | Cork floats line | Ligne separation couloirs



CORCHERA MODELO (*) CORK FLOATS LINE (*) LIGNE SEPARATION (*)

- ROMM2** 25
- ROMM5** 50

Anclajes no incluidos
Anchorages not included
Anclages pas compris



ANCLAJE INCLINADO SLOPING ANCHORAGE ANCRAGE INCLINÉ

- ANIH1** Ø43 Tubo | Tube | TUBEZ
- ANIH2** Ø48 Tubo | Tube | TUBEZ



ANCLAJE PLANO FLAT ANCHORAGE ANCRAGE PLAT

- ANPH1** Ø43 Tubo | Tube | TUBEZ
- ANPH2** Ø48 Tubo | Tube | TUBEZ



SOPORTE CORCHERA CORK FLOATS HOLDER SUPPORT LIGNE SÉPARATION COULOIRS

- SPCH1** Ø43 Anclaje | Anchorage Anclaje



COPA ANCLAJE ANCHOR CUP COUPE D'ANCRE

- CAE00** Anclaje escamotable Retractable anchor Ancre rétractable



ANCLAJE TORNILLO SCREW ANCHOR ANCRAGE VIS

- ANTH1** Ø43 Tubo | Tube | TUBEZ

Escaleras | Ladders | Échelles



ESCALERA CON PASAMANOS MODELO 1000
LADDER WITH HANDRAIL MODEL 1000
ÉCHELLE AVEC RAMPE MODEL 1000

MILX3
3 Peldaños | Steps | Marches
MILX4
4 Peldaños | Steps | Marches



ESCALERA MODELO PARTIDA
MODEL SPLIT LADDERS
ÉCHELLE AVEC RAMPE SÉPARÉE

PTDX3
3 Peldaños | Steps | Marches
PTDX4
4 Peldaños | Steps | Marches



ESCALERA PARTIDA MODELO ERGO
LADDER WITH HANDRAIL ERGO MODEL
ÉCHELLE SÉPARÉE MODEL ERGO

EPEZ3
3 Peldaños | Steps | Marches
EPEZ4
4 Peldaños | Steps | Marches



ESCALERA ASIMÉTRICO
ASYMMETRIC LADDER
ÉCHELLE ASYMÉTRIQUE

SMA00
2 Pasamanos | Handrail | Rampes1000



SALIDAS ANCLAJE INTERIOR / EXTERIOR
EXTERNAL / INTERNAL HOLDER EXITS
SORTIES EXTÉRIEUR / INTÉRIEUR POUR ENCASTRER

PAS00
043 Acero Inox | Steel Inox | Acier Inox

Señalización | Signs | Signalisation



SEÑALIZACIÓN SALIDA FALSA PARA POSTES (*)
FALSE START SIGNALING FOR POLES (*)
SIGNALIZATION FAUSSE SORTIE (*)

SS FH 1
Ø43 Postes | Poles | Poteaux
SS FH 2
Ø48 Postes | Poles | Poteaux

SS FFC
Cuerda poliéster | Polyester rope | Corde polyester
(*) Anclajes no incluidos | Anchorages not included | Ancrages pas compris



PODIUM SALIDA NADADORES (*)
SWIMMERS' START PODIUM (*)
PODIUM NAGEURS (*)

PDAH7
70 cm altura - azul
70 cm high - blue
70 cm hauteur - bleu

(*) Numeración no incluida
Podium numbers not included
Numéros des podiums pas considérés



BANDERINES (*)
SIGNAL FLAGS (*)
POTEAUX FANIONS (*)

BDNH1
Ø43 Postes | Poles | Poteaux
BDNH2
Ø48 Postes | Poles | Poteaux

BDNHBC
2 Cuerdas y bandera | Strings and signal flags | Cordes et fanion
(*) Anclajes no incluidos | Anchorages not included | Ancrages pas compris



SALVAVIDAS
LIFE PRESERVER
BOUÉE DE SAUVETAGE

SAL PL
Plástico | Plastic | Plastique
SAL LN
Lona | Canvas | Toile



ELEVADOR HIDRÁULICO
HYDRAULIC ELEVATOR
ÉLÉVATEUR HYDRAULIQUE

ELVML
Pasamanos
Handrail
Rampes1000
ELV65
Pasamano
Handrail | Rampes 650

Señalización | Signs | Signalisation



SOPORTE SALVAVIDAS
LIFE PRESERVER SUPPORT
SUPPORT BOUÉE

SSV00



PIE SOPORTE SALVAVIDAS
LIFE PRESERVER STAND
SUPPORT PIED BOUÉE
DE SAUVETAGE

PSV00



ANCLAJE POLIPROPILENO
POLYPROPYLENE ANCHORAGE
ANCRAGE EN POLYPROPYLENE

ANEH 1



DESAGÜE PVC
PVC DRAINS
DRAIN PVC

990



SILENCIADOR DE DESAGÜE
DRAIN SILENCER
SILENCIEUX

DS2



PP HOMOPOLÍMERO
PP HOMOPOLYMER
RONDELLE DE
HOMOPOLYMERE

EMB 00

Otras opciones | Other options | Autres options

Características técnicas | Technical characteristics | Caractéristiques techniques

EN 16165 (UNE 41.901)	Rd < 15	CLASE	CLASS	CLASSE 0
	15 < Rd ≤ 35	CLASE	CLASS	CLASSE 1
	35 < Rd ≤ 45	CLASE	CLASS	CLASSE 2
	Rd > 45	CLASE	CLASS	CLASSE 3

EN 16165 (DIN 51130) PIE CALZADO FOOTWEAR PIED CHAUSSE	R9 > 6° - 10°
	R10 > 10° - 19°
	R11 > 19° - 27°
	R12 > 27° - 35°

EN 16165 (DIN 51097) PIE DESCALZO BARE FEET PIEDS NUS	CLASE CLASS CLASSE A ≥12°
	CLASE CLASS CLASSE B ≥18°
	CLASE CLASS CLASSE C ≥24°

CORRESPONDANCE DES NORMES PIEDS NUS			CORRESPONDANCE DES NORMES PIEDS CHAUSSÉS		
Normes Française	Normes européenne		Normes Française	Normes européenne	
PNG		≥6°	PC6	R9	≥6°
PN12	A	≥12°	PC10	R10	≥10°
PN18	B	≥18°	PC20	R11	≥20°
PN24	C	≥24°	PC27	R12	≥27°
			PC35	R13	≥35°



Debrecen Aquaticum Strand | Hungary | Architect: Bord Architect Studio

Coefficientes antideslizamiento | Anti-slip coefficients | Coefficients d'anti-glisement





		EN 16165									
		UNE 41901			DIN 51130 XP P-05-010				DIN 51097 XP P-05-010		ANSI A 326.3 (ANSI A 137-1)
		Class 1	Class 2	Class 3	R9 / PC6	R10 / PC10	R11 / PC20	R12 / PC27	Class B / PN18	Class C / PN 24	Smooth >0.42 Anti-slip > 0.55
Unique pools	mythos	smooth	●			●					
		anti-slip			●			●		●	●
	iconic	smooth	●			●					
		pastilla anti-slip			●			●		●	●
	trésor	anti-slip			●		●			●	●
	stela	smooth	●			●					●
		anti-slip			●			●		●	●
	pietro	pastilla anti-slip			●			●		●	●
	serena	anti-slip			●			●		●	●
	alma	smooth	●			●					●
		anti-slip			●			●		●	●
	mystery	smooth	●			●					
		anti-slip			●			●		●	●
	aqua	pastilla anti-slip			●					●	
	mosaic	anti-slip			●					●	
	Indugres	Indubeige R9	●			●					
		Indubeige R10		●			●			●	
		Indu Grey R10			●		●			●	
		Indubeige R12			●			●		●	
		Indu Grey R12			●			●		●	

NORMATIVA DE ENSAYO TESTING REGULATIONS NORME D'ESSAI	NORMATIVA EN 14411	Unique Pools				
		Mythos Trésor Pietro Alma	Iconic Stela Serena Mistry	Aqua	Indugres 100% Biostop	Mosaic

Características dimensionales | Dimensions et aspect de la surface | Dimensions et aspect de la surface

 ISO 10545-2	Características dimensionales Water absorption Dimensions et aspect de la surface	Exigida Required Exigée	Garantizada Guaranteed Garantie	Garantizada Guaranteed Garantie	Garantizada Guaranteed Garantie	Garantizada Guaranteed Garantie
---	---	-------------------------------	---------------------------------------	---------------------------------------	---------------------------------------	---------------------------------------

Propiedades físicas | Physical properties | Propriétés physiques

 ISO 10545-3	Absorción de agua Modulus of rupture Absorption d'eau	Grupo A1a E < 0,5 % Grupo B1a E < 0,5 %	E < 0,5 %	E < 0,5 %	E < 0,5 %	E < 0,5 %
 ISO 10545-4	Resistencia a la flexión Resistance to deep abrasion Résistance à la flexion	Grupo A1a > 28 N/mm ² Grupo B1a > 35 N/mm ²	> 40 N/mm ²	> 40 N/mm ²	> 40 N/mm ²	
 ISO 10545-6	Resistencia a la abrasión profunda Thermal shock resistance Résistance à l'abrasion	< 175 mm ³	-	-	< 175 mm ³	
 ISO 10545-9	Resistencia al choque térmico Frost resistance Résistance au choc thermique	Exigida Required Exigée	Garantizada Guaranteed Garantie	Garantizada Guaranteed Garantie	Garantizada Guaranteed Garantie	
 ISO 10545-12	Resistencia a la helada Dimensions and surface quality Résistance au gel	Exigida Required Exigée	Garantizada Guaranteed Garantie	Garantizada Guaranteed Garantie	Garantizada Guaranteed Garantie	Garantizada Guaranteed Garantie

Propiedades químicas | Chemical properties | Propriétés chimiques

 ISO 10545-13	Resistencia química ⁽¹⁾ Chemical resistance ⁽¹⁾ Résistance chimique ⁽¹⁾	Min. Clase B	A / LA / HA	A / LA / HA	A / LA / HA	A / LA / HA
 ISO 10545-14	Resistencia a las manchas Stain resistance Résistance aux tâches	Min. Clase 3	Garantizada Guaranteed Garantie	Garantizada Guaranteed Garantie	Garantizada Guaranteed Garantie	Garantizada Guaranteed Garantie
ISO 22196 STM E 2149 JIS Z 2801: 2000	Eficacia antibacteriana Antibacterial activity Efficacité antibactérienne	-	-	-	Garantizada Guaranteed Garantie	-

⁽¹⁾ Excepto ácido fluorhídrico y sus compuestos. Piezas base: grupo B1a. Piezas especiales: grupo A1a

⁽¹⁾ Except hydrofluoric acid and its components. Base pieces: grupo B1a. Trim pieces: Group A1a

⁽¹⁾ À l'exception de l'acide fluorhydrique et de ses composés. Pièces de base: Grupo B1a grès cerame pressé. Pièces spéciales: Grupo A1a grès cerame étiré



Debrecen Aquaticum Strand | Hungary | Architect: Bord Architect Studio



Portada y contraportada | Cover and back cover | Couverture et quatrième de couverture: **Centres Enjoy | Oviedo, Spain | Architect: Jorge Barata**



Rosa Gres, SLU

Oficina Central - Central Office - Bureau Central

Ctra. Sant Cugat, km. 3

08290 Cerdanyola, Barcelona, Spain

Tel. + 34 93 586 30 60

Ventas: + 34 93 586 37 00

Export Sales: + 34 93 586 37 02

info@rosagres.com

www.rosagres.com

Fábrica - Factory - Fabrique

Pol. Ind. Mas Vell

Ramón Sugrañes, 1

43144 Vallmoll, Tarragona, Spain

Rosa Gres France, SARL

64140 Lons, France

Tel. + 00 33 411 92 00 30

contact@rosagres.com

administration@rosagres.com

www.rosagres.com/fr

Julio 2023

